



Is Now Part of



**ON Semiconductor®**

To learn more about ON Semiconductor, please visit our website at  
[www.onsemi.com](http://www.onsemi.com)

Please note: As part of the Fairchild Semiconductor integration, some of the Fairchild orderable part numbers will need to change in order to meet ON Semiconductor's system requirements. Since the ON Semiconductor product management systems do not have the ability to manage part nomenclature that utilizes an underscore (\_), the underscore (\_) in the Fairchild part numbers will be changed to a dash (-). This document may contain device numbers with an underscore (\_). Please check the ON Semiconductor website to verify the updated device numbers. The most current and up-to-date ordering information can be found at [www.onsemi.com](http://www.onsemi.com). Please email any questions regarding the system integration to [Fairchild\\_questions@onsemi.com](mailto:Fairchild_questions@onsemi.com).

ON Semiconductor and the ON Semiconductor logo are trademarks of Semiconductor Components Industries, LLC dba ON Semiconductor or its subsidiaries in the United States and/or other countries. ON Semiconductor owns the rights to a number of patents, trademarks, copyrights, trade secrets, and other intellectual property. A listing of ON Semiconductor's product/patent coverage may be accessed at [www.onsemi.com/site/pdf/Patent-Marking.pdf](http://www.onsemi.com/site/pdf/Patent-Marking.pdf). ON Semiconductor reserves the right to make changes without further notice to any products herein. ON Semiconductor makes no warranty, representation or guarantee regarding the suitability of its products for any particular purpose, nor does ON Semiconductor assume any liability arising out of the application or use of any product or circuit, and specifically disclaims any and all liability, including without limitation special, consequential or incidental damages. Buyer is responsible for its products and applications using ON Semiconductor products, including compliance with all laws, regulations and safety requirements or standards, regardless of any support or applications information provided by ON Semiconductor. "Typical" parameters which may be provided in ON Semiconductor data sheets and/or specifications can and do vary in different applications and actual performance may vary over time. All operating parameters, including "Typicals" must be validated for each customer application by customer's technical experts. ON Semiconductor does not convey any license under its patent rights nor the rights of others. ON Semiconductor products are not designed, intended, or authorized for use as a critical component in life support systems or any FDA Class 3 medical devices or medical devices with a same or similar classification in a foreign jurisdiction or any devices intended for implantation in the human body. Should Buyer purchase or use ON Semiconductor products for any such unintended or unauthorized application, Buyer shall indemnify and hold ON Semiconductor and its officers, employees, subsidiaries, affiliates, and distributors harmless against all claims, costs, damages, and expenses, and reasonable attorney fees arising out of, directly or indirectly, any claim of personal injury or death associated with such unintended or unauthorized use, even if such claim alleges that ON Semiconductor was negligent regarding the design or manufacture of the part. ON Semiconductor is an Equal Opportunity/Affirmative Action Employer. This literature is subject to all applicable copyright laws and is not for resale in any manner.

# KA393 / KA393A, KA2903 Dual Differential Comparator

## Features

- Single Supply Operation: 2V to 36V
- Dual Supply Operation:  $\pm 1V$  to  $\pm 18V$
- Allow Comparison of Voltages Near Ground Potential
- Low Current Drain: 800 $\mu A$  Typical
- Compatible with all Forms of Logic
- Low Input Bias Current: 25nA Typical
- Low Input Offset Current:  $\pm 5nA$  Typical
- Low Offset Voltage:  $\pm 1mV$  Typical

## Description

The KA393 / KA393A / KA2903 series consists of two independent voltage comparators designed to operate from a single power supply over a wide voltage range.



Figure 1. DIP Package



Figure 2. SOIC Package

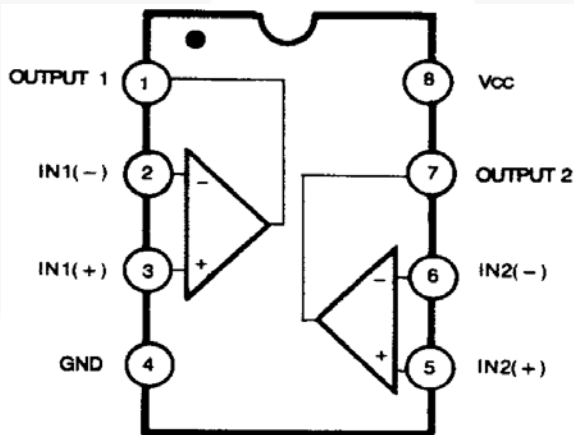

Figure 3. Block Diagram

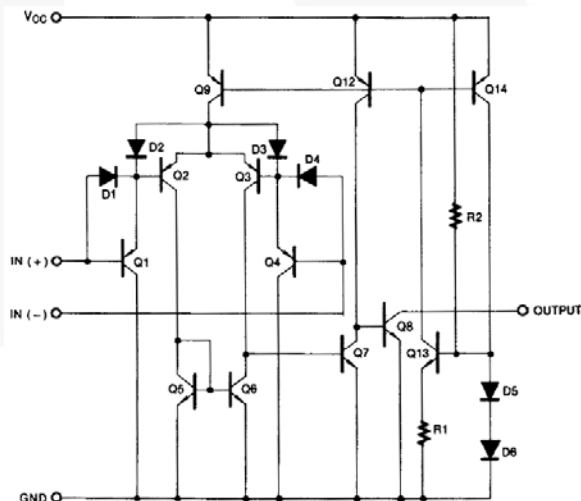

Figure 4. Schematic

## Ordering Information

Part Number	Operating Temperature Range	Package	Packing Method
KA393	0 to 70°C	8-Lead DIP	Tube
KA393A	0 to 70°C		Tube
KA393DTF	0 to 70°C	8-Lead SOIC	Tape and Reel
KA393ADTF	0 to 70°C		Tape and Reel
KA2903DTF	-40 to 85°C		Tape and Reel

## Absolute Maximum Ratings

Stresses exceeding the absolute maximum ratings may damage the device. The device may not function or be operable above the recommended operating conditions and stressing the parts to these levels is not recommended. In addition, extended exposure to stresses above the recommended operating conditions may affect device reliability. The absolute maximum ratings are stress ratings only.

Symbol	Parameter		Min.	Max.	Unit
$V_{CC}$	Power Supply Voltage		$\pm 18$	36	V
$V_{I(DIFF)}$	Differential Input Voltage			36	V
$V_I$	Input Voltage		-0.3	+36.0	V
	Output Short Circuit to GND		Continuous		
$P_D$	Power Dissipation, $T_A = 25^\circ\text{C}$	8-DIP		1040	mW
		8-SOIC		480	
$T_{OPR}$	Operating Temperature	KA393 / KA393A	0	+70	$^\circ\text{C}$
		KA2903	-40	+85	
$T_{STG}$	Storage Temperature		-65	+150	$^\circ\text{C}$
$R\theta_{JA}$	Thermal Resistance, Junction-to-Ambient	8-DIP		120	$^\circ\text{C}/\text{W}$
		8-SOIC		260	
ESD	Electrostatic Discharge Capability	Human Body Model, JESD22-A114		1000	V
		Charged Device Model, JESD22-C101		2000	

## Electrical Characteristics

$V_{CC} = 5V$  and  $T_A = 25^\circ C$ , Unless otherwise specified.

Symbol	Parameter	Conditions	Min.	Typ.	Max.	Unit	
$V_{IO}$	Input Offset Voltage	KA393	$V_{O(P)} = 1.4V, R_S = 0\Omega$		$\pm 1$	$\pm 5$	mV
			$V_{CM} = 0$ to $1.5V, T_A = 0$ to $+70^\circ C$			$\pm 9$	
		KA393A	$V_{O(P)} = 1.4V, R_S = 0\Omega$		$\pm 1$	$\pm 2$	
			$V_{CM} = 0$ to $1.5V, T_A = 0$ to $+70^\circ C$			$\pm 4$	
$I_{IO}$	Input Offset Current	$T_A = 25^\circ C$		$\pm 5$	$\pm 50$	nA	
		$T_A = 0$ to $+70^\circ C$			$\pm 150$		
$I_{BIAS}$	Input Bias Current	$T_A = 25^\circ C$		65	250	nA	
		$T_A = 0$ to $+70^\circ C$			400		
$V_{I(R)}$	Input Common-Mode Voltage Range	$T_A = 25^\circ C$	0		$V_{CC} - 1.5$	V	
		$T_A = 0$ to $+70^\circ C$	0		$V_{CC} - 2.0$		
$I_{CC}$	Supply Current	$R_L = \infty, V_{CC} = 5V$		0.6	1.0	mA	
		$R_L = \infty, V_{CC} = 30V$		0.8	2.5		
$V_G$	Voltage Gain	$V_{CC} = 15V, R_L \geq 15K\Omega$ , (for Large $V_{O(P-P)}$ Swing)	50	200		V/mV	
$t_{LRES}$	Large Signal Response Time	$V_I = \text{TTL Logic Swing } V_{REF} = 1.4V$ , $V_{RL} = 5V, R_L = 5.1K\Omega$		350		ns	
$t_{RES}$	Response Time	$V_{RL} = 5V, R_L = 5.1K\Omega$		1.4		$\mu s$	
$I_{SINK}$	Output Sink Current	$V_{I(-)} \geq 1V, V_{I(+)} = 0V, V_{O(P)} \leq 1.5V$	6	18		mA	
$V_{SAT}$	Output Saturation Voltage	$V_{I(-)} \geq 1V, V_{I(+)} = 0V$		160	400	mV	
		$I_{SINK} = 4mA, T_A = 0$ to $+70^\circ C$			700		
$I_{O(LKG)}$	Output Leakage Current	$V_{I(-)} = 0V, V_{I(+)} = 1V, V_{O(P)} = 5V$		0.1		nA	
		$V_{I(-)} = 0V, V_{I(+)} = 1V, V_{O(P)} = 30V$			1.0	$\mu A$	

### KA2903

$V_{IO}$	Input Offset Voltage	$V_{O(P)} = 1.4V, R_S = 0\Omega$		$\pm 1$	$\pm 7$	mV
		$V_{CM} = 0$ to $1.5V, T_A = -40$ to $+85^\circ C$		$\pm 9$	$\pm 15$	
$I_{IO}$	Input Offset Current	$T_A = 25^\circ C$		$\pm 5$	$\pm 50$	nA
		$T_A = -40$ to $+85^\circ C$		$\pm 50$	$\pm 200$	
$I_{BIAS}$	Input Bias Current	$T_A = 25^\circ C$		65	250	nA
		$T_A = -40$ to $+85^\circ C$			500	
$V_{I(R)}$	Input Common-Mode Voltage Range	$T_A = 25^\circ C$	0		$V_{CC} - 1.5$	V
		$T_A = -40$ to $+85^\circ C$	0		$V_{CC} - 2.0$	
$I_{CC}$	Supply Current	$R_L = \infty, V_{CC} = 5V$		0.6	1.0	mA
		$R_L = \infty, V_{CC} = 30V$		1.0	2.5	
$V_G$	Voltage Gain	$V_{CC} = 15V, R_L \geq 15K\Omega$ , (for Large $V_{O(P-P)}$ Swing)	25	100		V/mV
$t_{LRES}$	Large Signal Response Time	$V_I = \text{TTL Logic Swing } V_{REF} = 1.4V$ , $V_{RL} = 5V, R_L = 5.1K\Omega$		350		ns
$t_{RES}$	Response Time	$V_{RL} = 5V, R_L = 5.1K\Omega$		1.5		$\mu s$
$I_{SINK}$	Output Sink Current	$V_{I(-)} \geq 1V, V_{I(+)} = 0V, V_{O(P)} \leq 1.5V$	6	16		mA
$V_{SAT}$	Output Saturation Voltage	$V_{I(-)} \geq 1V, V_{I(+)} = 0V$		160	400	mV
		$I_{SINK} = 4mA, T_A = -40$ to $+85^\circ C$			700	
$I_{O(LKG)}$	Output Leakage Current	$V_{I(-)} = 0V, V_{I(+)} = 1V, V_{O(P)} = 5V$		0.1		nA
		$V_{I(-)} = 0V, V_{I(+)} = 1V, V_{O(P)} = 30V$			1.0	$\mu A$

Typical Performance Characteristics

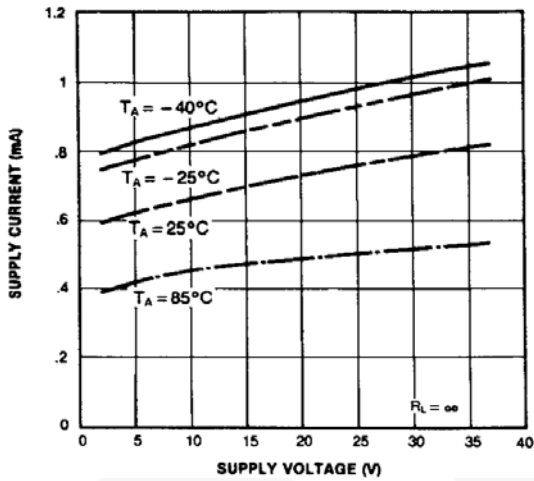

Figure 5. Supply Current vs. Supply Voltage

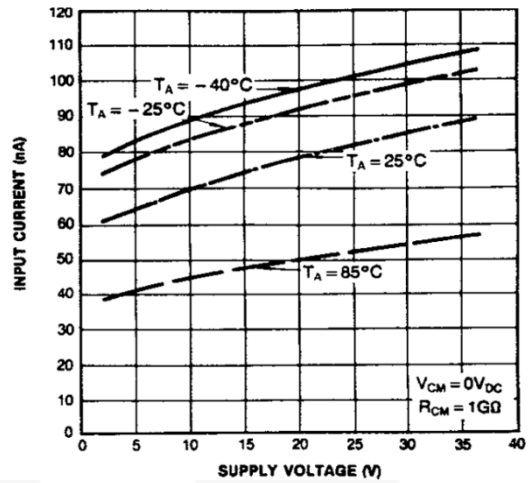

Figure 6. Input Current vs. Supply Voltage

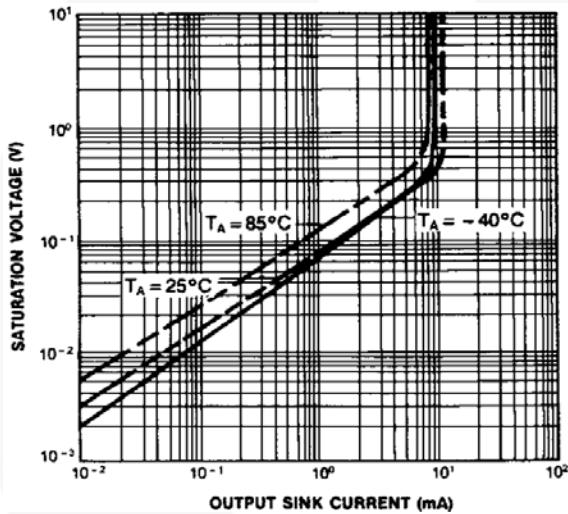

Figure 7. Output Saturation Voltage vs. Sink Current

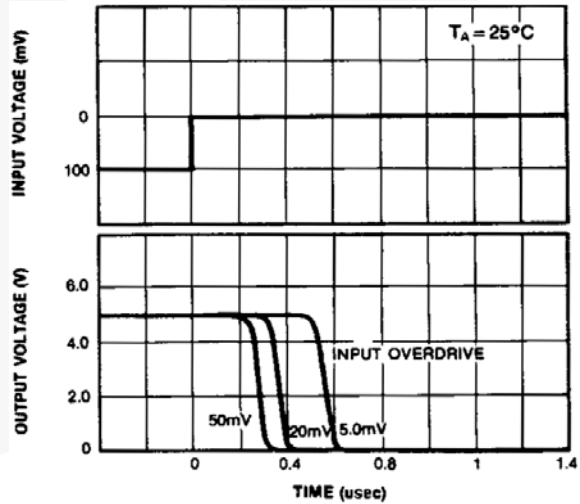

Figure 8. Response Time for Various Input Overdrive-Negative Transitions

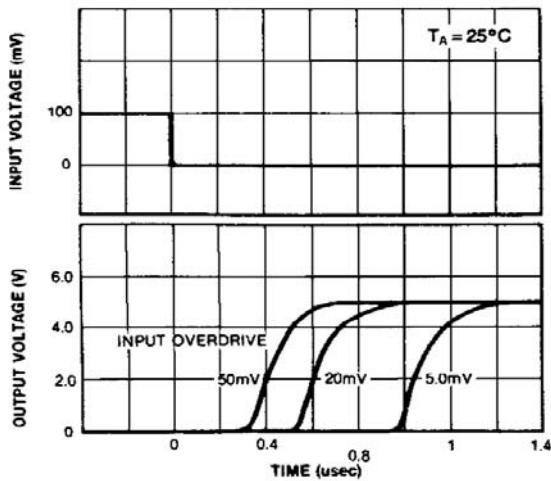

Figure 9. Response Time for Various Input Overdrive-Positive Transitions

Physical Dimensions

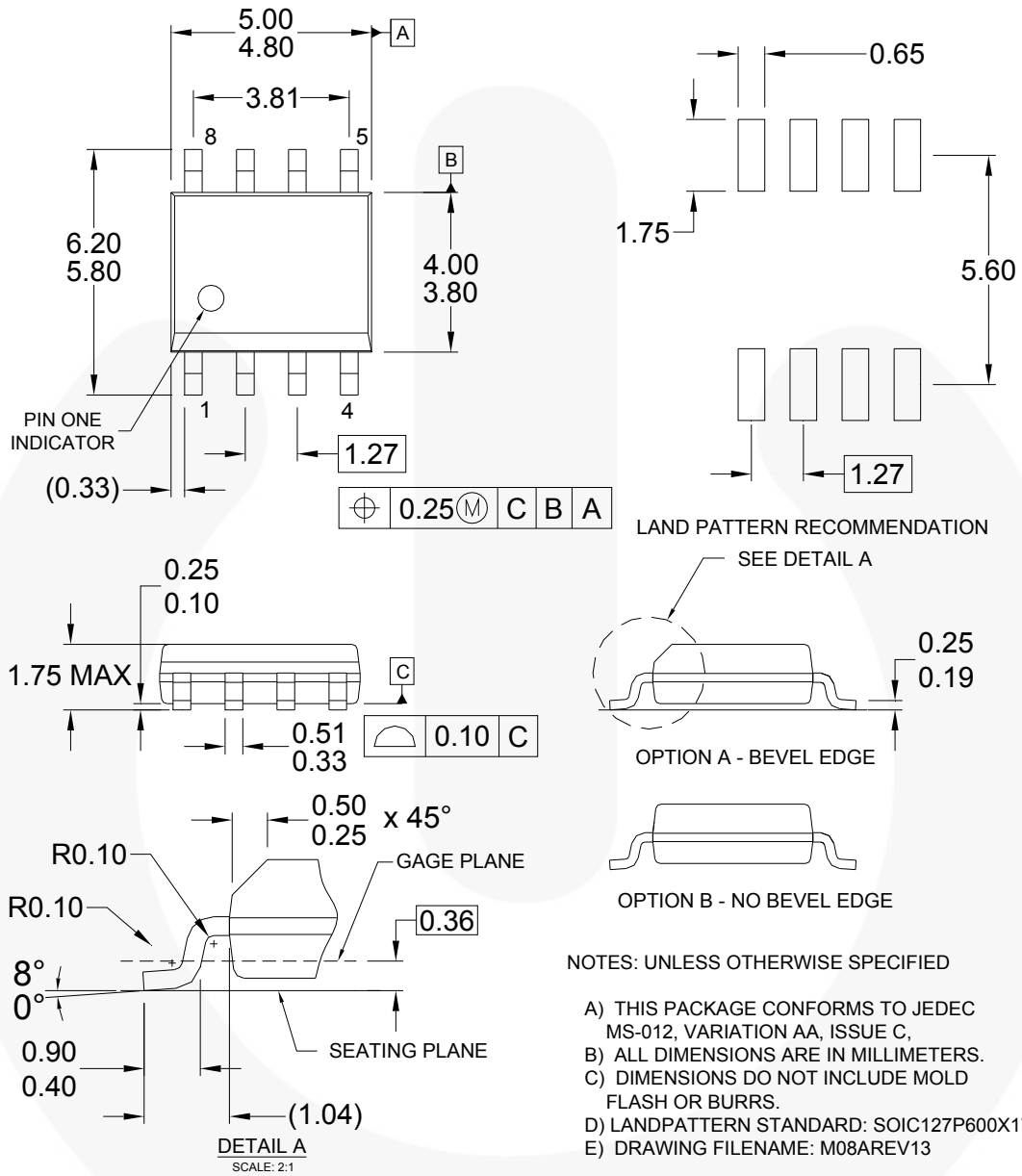
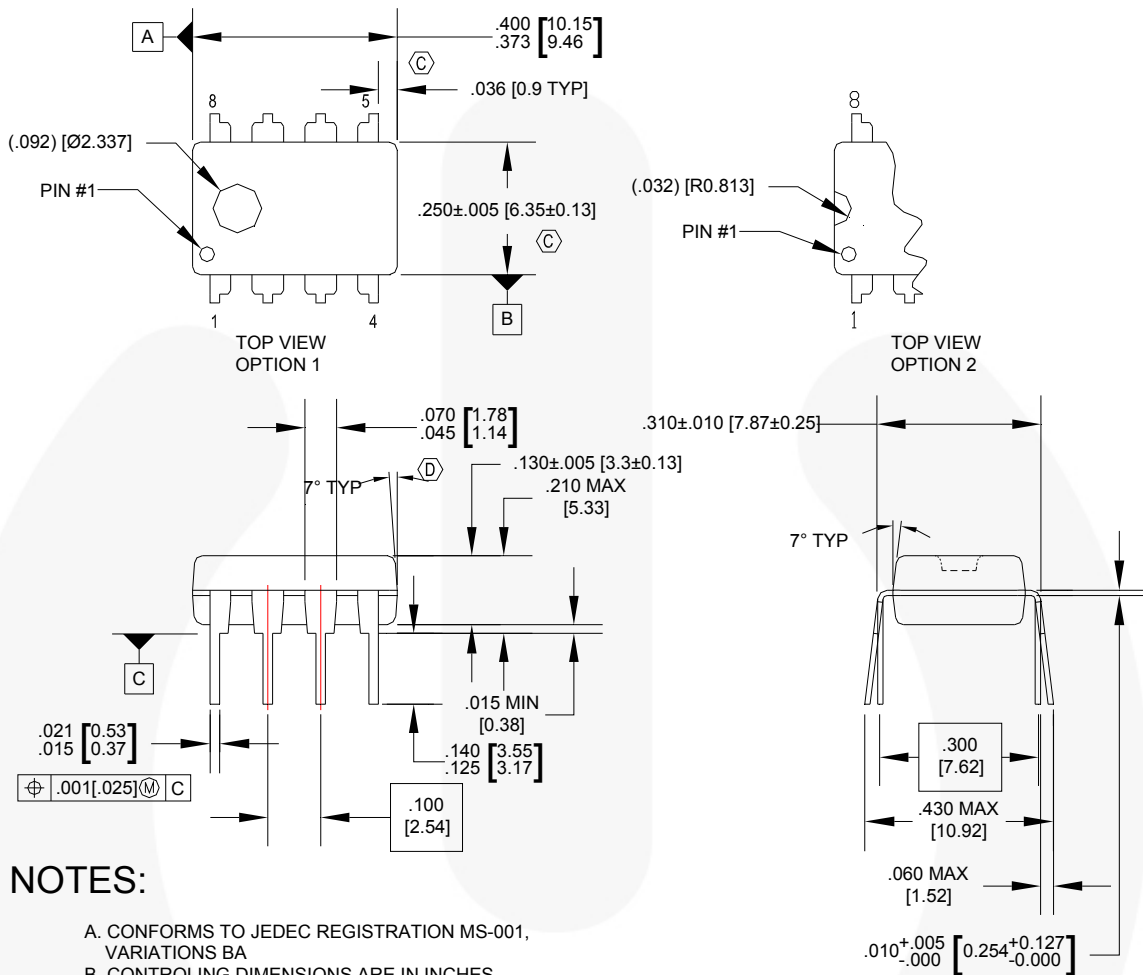

Figure 10.8-Lead, Small-Outline Integrated Circuit (SOIC), JEDEC MS-012, .150" Narrow Body

Package drawings are provided as a service to customers considering Fairchild components. Drawings may change in any manner without notice. Please note the revision and/or date on the drawing and contact a Fairchild Semiconductor representative to verify or obtain the most recent revision. Package specifications do not expand the terms of Fairchild's worldwide terms and conditions, specifically the warranty therein, which covers Fairchild products.

Always visit Fairchild Semiconductor's online packaging area for the most recent package drawings:  
<http://www.fairchildsemi.com/packaging/>.

Physical Dimensions



NOTES:

- A. CONFORMS TO JEDEC REGISTRATION MS-001, VARIATIONS BA
- B. CONTROLLING DIMENSIONS ARE IN INCHES  
REFERENCE DIMENSIONS ARE IN MILLIMETERS
- C. DOES NOT INCLUDE MOLD FLASH OR PROTRUSIONS.  
MOLD FLASH OR PROTRUSIONS SHALL NOT EXCEED  
.010 INCHES OR 0.25MM.
- D. DOES NOT INCLUDE DAMBAR PROTRUSIONS.  
DAMBAR PROTRUSIONS SHALL NOT EXCEED  
.010 INCHES OR 0.25MM.
- E. DIMENSIONING AND TOLERANCING  
PER ASME Y14.5M-1994.

N08EREVG

Figure 1. 8-Lead, DIP, JEDEC MS-001, .300" Wide





Package drawings are provided as a service to customers considering Fairchild components. Drawings may change in any manner without notice. Please note the revision and/or date on the drawing and contact a Fairchild Semiconductor representative to verify or obtain the most recent revision. Package specifications do not expand the terms of Fairchild's worldwide terms and conditions, specifically the warranty therein, which covers Fairchild products.

Always visit Fairchild Semiconductor's online packaging area for the most recent package drawings:  
<http://www.fairchildsemi.com/packaging/>.



### TRADEMARKS

The following includes registered and unregistered trademarks and service marks, owned by Fairchild Semiconductor and/or its global subsidiaries, and is not intended to be an exhaustive list of all such trademarks.

AccuPower™	FPS™	Power-SPM™	The Power Franchise®
Auto-SPM™	F-PFST™	PowerTrench®	The Right Technology for Your Success™
AX-CAP™	FRFET®	PowerXS™	
BitSiC®	Global Power Resource™	Programmable Active Droop™	TinyBoost™
Build it Now™	Green FPS™	QFET®	TinyBuck™
CorePLUS™	Green FPS™ e-Series™	QS™	TinyCalc™
CorePOWER™	Gmax™	Quiet Series™	TinyLogic®
CROSSVOLT™	GTO™	RapidConfigure™	TINYOPTO™
CTL™	IntelliMAX™		TinyPower™
Current Transfer Logic™	ISOPLANAR™	Saving our world, 1mW/W/kW at a time™	TinyPWM™
DEUXPEED®	MegaBuck™	SignalWise™	TinyWire™
Dual Cool™	MICROCOUPLER™	SmartMax™	TranSiC®
EcoSPARK®	MicroFET™	SMART START™	TriFault Detect™
EfficientMax™	MicroPak™	SPM®	TRUECURRENT®*
ESBC™	MicroPak2™	STEALTH™	µSerDes™
	MillerDrive™	SuperFET®	
Fairchild®	MotionMax™	SuperSOT™-3	UHC®
Fairchild Semiconductor®	Motion-SPM™	SuperSOT™-6	Ultra FRFET™
FACT Quiet Series™	miWSaver™	SuperSOT™-8	UniFET™
FACT™	OptoHi™	SupreMOS®	VCX™
FAST®	OPTOLOGIC®	SyncFET™	VisualMax™
FastvCore™	OPTOPLANAR®	Sync-Lock™	XST™
FETBench™			
FlashWriter®*	PDP SPM™		

\* Trademarks of System General Corporation, used under license by Fairchild Semiconductor.

### DISCLAIMER

FAIRCHILD SEMICONDUCTOR RESERVES THE RIGHT TO MAKE CHANGES WITHOUT FURTHER NOTICE TO ANY PRODUCTS HEREIN TO IMPROVE RELIABILITY, FUNCTION, OR DESIGN. FAIRCHILD DOES NOT ASSUME ANY LIABILITY ARISING OUT OF THE APPLICATION OR USE OF ANY PRODUCT OR CIRCUIT DESCRIBED HEREIN; NEITHER DOES IT CONVEY ANY LICENSE UNDER ITS PATENT RIGHTS, NOR THE RIGHTS OF OTHERS. THESE SPECIFICATIONS DO NOT EXPAND THE TERMS OF FAIRCHILD'S WORLDWIDE TERMS AND CONDITIONS, SPECIFICALLY THE WARRANTY THEREIN, WHICH COVERS THESE PRODUCTS.

### LIFE SUPPORT POLICY

FAIRCHILD'S PRODUCTS ARE NOT AUTHORIZED FOR USE AS CRITICAL COMPONENTS IN LIFE SUPPORT DEVICES OR SYSTEMS WITHOUT THE EXPRESS WRITTEN APPROVAL OF FAIRCHILD SEMICONDUCTOR CORPORATION.

As used herein:

1. Life support devices or systems are devices or systems which, (a) are intended for surgical implant into the body or (b) support or sustain life, and (c) whose failure to perform when properly used in accordance with instructions for use provided in the labeling, can be reasonably expected to result in a significant injury of the user.
2. A critical component in any component of a life support, device, or system whose failure to perform can be reasonably expected to cause the failure of the life support device or system, or to affect its safety or effectiveness.

### ANTI-COUNTERFEITING POLICY

Fairchild Semiconductor Corporation's Anti-Counterfeiting Policy. Fairchild's Anti-Counterfeiting Policy is also stated on our external website, [www.fairchildsemi.com](http://www.fairchildsemi.com), under Sales Support.

Counterfeiting of semiconductor parts is a growing problem in the industry. All manufacturers of semiconductor products are experiencing counterfeiting of their parts. Customers who inadvertently purchase counterfeit parts experience many problems such as loss of brand reputation, substandard performance, failed applications, and increased cost of production and manufacturing delays. Fairchild is taking strong measures to protect ourselves and our customers from the proliferation of counterfeit parts. Fairchild strongly encourages customers to purchase Fairchild parts either directly from Fairchild or from Authorized Fairchild Distributors who are listed by country on our web page cited above. Products customers buy either from Fairchild directly or from Authorized Fairchild Distributors are genuine parts, have full traceability, meet Fairchild's quality standards for handling and storage and provide access to Fairchild's full range of up-to-date technical and product information. Fairchild and our Authorized Distributors will stand behind all warranties and will appropriately address any warranty issues that may arise. Fairchild will not provide any warranty coverage or other assistance for parts bought from Unauthorized Sources. Fairchild is committed to combat this global problem and encourage our customers to do their part in stopping this practice by buying direct or from authorized distributors.

### PRODUCT STATUS DEFINITIONS

#### Definition of Terms

Datasheet Identification	Product Status	Definition
Advance Information	Formative / In Design	Datasheet contains the design specifications for product development. Specifications may change in any manner without notice.
Preliminary	First Production	Datasheet contains preliminary data; supplementary data will be published at a later date. Fairchild Semiconductor reserves the right to make changes at any time without notice to improve design.
No Identification Needed	Full Production	Datasheet contains final specifications. Fairchild Semiconductor reserves the right to make changes at any time without notice to improve the design.
Obsolete	Not In Production	Datasheet contains specifications on a product that is discontinued by Fairchild Semiconductor. The datasheet is for reference information only.

Rev. I54



ON Semiconductor and  are trademarks of Semiconductor Components Industries, LLC dba ON Semiconductor or its subsidiaries in the United States and/or other countries. ON Semiconductor owns the rights to a number of patents, trademarks, copyrights, trade secrets, and other intellectual property. A listing of ON Semiconductor's product/patent coverage may be accessed at [www.onsemi.com/site/pdf/Patent-Marking.pdf](http://www.onsemi.com/site/pdf/Patent-Marking.pdf). ON Semiconductor reserves the right to make changes without further notice to any products herein. ON Semiconductor makes no warranty, representation or guarantee regarding the suitability of its products for any particular purpose, nor does ON Semiconductor assume any liability arising out of the application or use of any product or circuit, and specifically disclaims any and all liability, including without limitation special, consequential or incidental damages. Buyer is responsible for its products and applications using ON Semiconductor products, including compliance with all laws, regulations and safety requirements or standards, regardless of any support or applications information provided by ON Semiconductor. "Typical" parameters which may be provided in ON Semiconductor data sheets and/or specifications can and do vary in different applications and actual performance may vary over time. All operating parameters, including "Typicals" must be validated for each customer application by customer's technical experts. ON Semiconductor does not convey any license under its patent rights nor the rights of others. ON Semiconductor products are not designed, intended, or authorized for use as a critical component in life support systems or any FDA Class 3 medical devices or medical devices with a same or similar classification in a foreign jurisdiction or any devices intended for implantation in the human body. Should Buyer purchase or use ON Semiconductor products for any such unintended or unauthorized application, Buyer shall indemnify and hold ON Semiconductor and its officers, employees, subsidiaries, affiliates, and distributors harmless against all claims, costs, damages, and expenses, and reasonable attorney fees arising out of, directly or indirectly, any claim of personal injury or death associated with such unintended or unauthorized use, even if such claim alleges that ON Semiconductor was negligent regarding the design or manufacture of the part. ON Semiconductor is an Equal Opportunity/Affirmative Action Employer. This literature is subject to all applicable copyright laws and is not for resale in any manner.

## PUBLICATION ORDERING INFORMATION

### LITERATURE FULFILLMENT:

Literature Distribution Center for ON Semiconductor  
19521 E. 32nd Pkwy, Aurora, Colorado 80011 USA  
**Phone:** 303-675-2175 or 800-344-3860 Toll Free USA/Canada  
**Fax:** 303-675-2176 or 800-344-3867 Toll Free USA/Canada  
**Email:** [orderlit@onsemi.com](mailto:orderlit@onsemi.com)

**N. American Technical Support:** 800-282-9855 Toll Free  
USA/Canada  
**Europe, Middle East and Africa Technical Support:**  
Phone: 421 33 790 2910  
**Japan Customer Focus Center**  
Phone: 81-3-5817-1050

**ON Semiconductor Website:** [www.onsemi.com](http://www.onsemi.com)  
**Order Literature:** <http://www.onsemi.com/orderlit>  
For additional information, please contact your local  
Sales Representative