

L1SS400CST5G

S-L1SS400CST5G

Switching diode

1. FEATURES

- We declare that the material of product compliance with RoHS requirements and Halogen Free.
- S- prefix for automotive and other applications requiring unique site and control change requirements; AEC-Q101 qualified and PPAP capable.
- Extremely small surface mounting type.
- High Speed.
- High reliability.

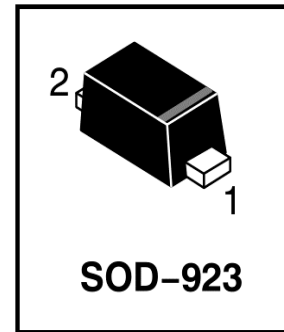

2. DEVICE MARKING AND ORDERING INFORMATION

Device	Marking	Shipping
L1SS400CST5G	3	8000/Tape&Reel



3. MAXIMUM RATINGS(Ta = 25°C)

Parameter	Symbol	Limits	Unit
Peak reverse voltage	VRM	90	V
DC reverse voltage	VR	80	V
Peak forward current	IFM	225	mA
Mean rectifying current	IO	100	mA
Surge current (1s)	Isurge	500	mA
Junction temperature	Tj	125	°C
Storage temperature	Tstg	-55~+125	°C

4. ELECTRICAL CHARACTERISTICS

Characteristic	Symbol	Min.	Typ.	Max.	Unit
Forward voltage (IF =100mA)	VF	-	-	1.2	V
Reverse current (VR =80V)	IR	-	-	0.1	μA
Capacitance between terminals (VR =0.5V , f=1MHz)	CT	-	0.72	3	pF
Reverse recovery time (VR =6V , IF =10mA , RL =100Ω)	trr	-	-	4	nS

5.ELECTRICAL CHARACTERISTICS CURVES

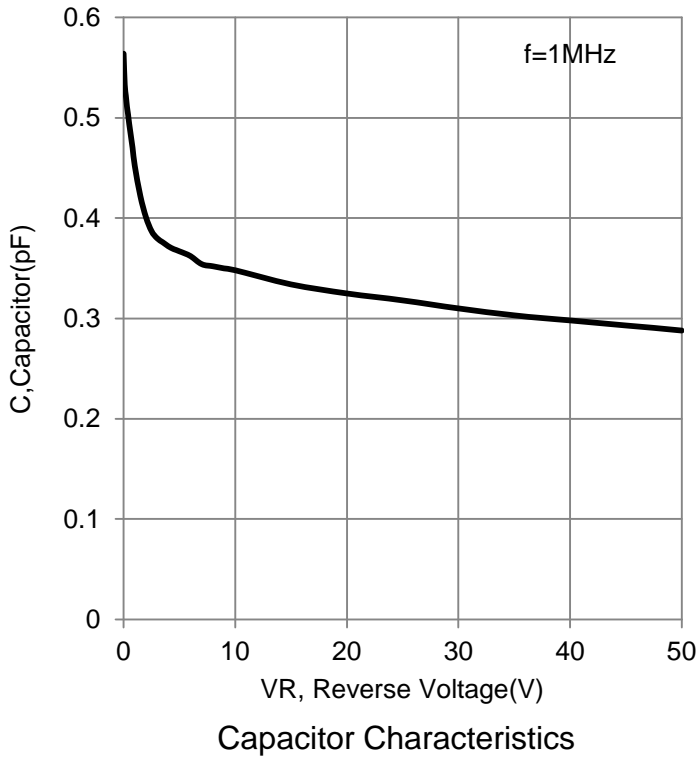
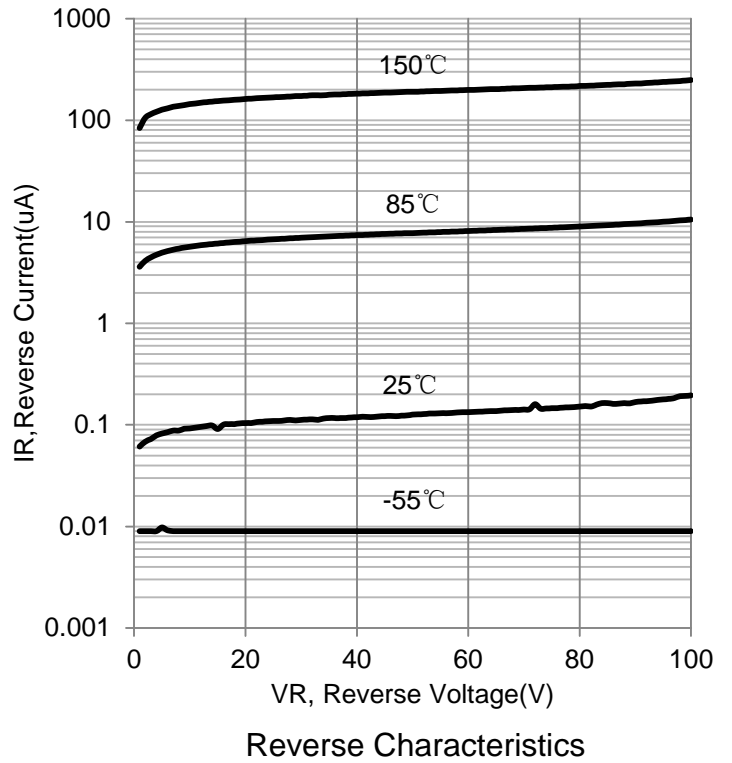
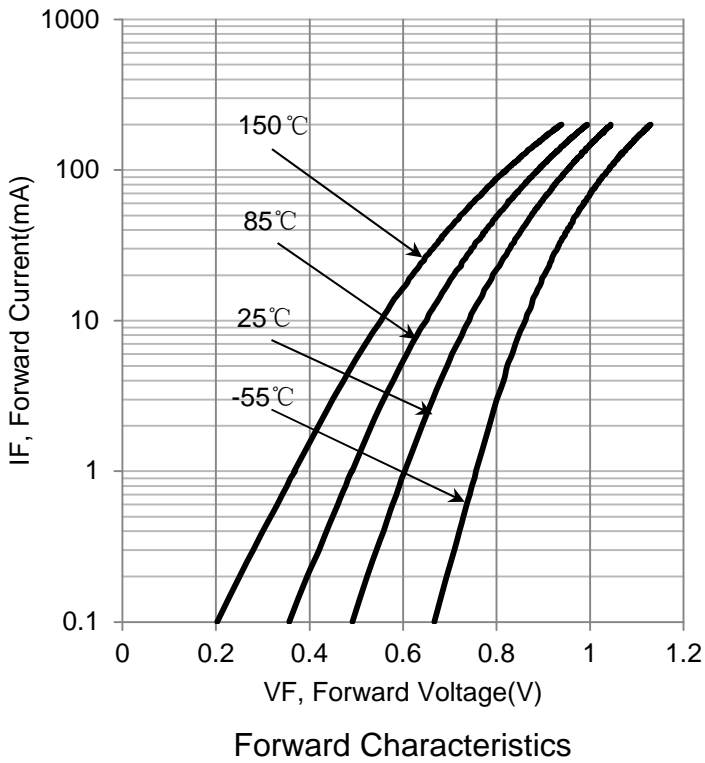

6. OUTLINE AND DIMENSIONS

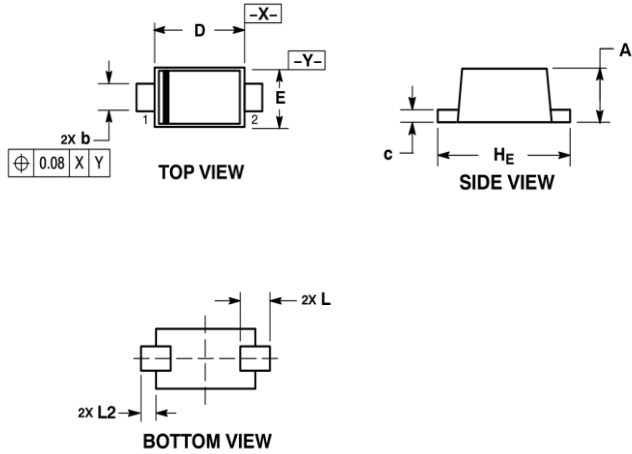

Notes:

1. DIMENSIONING AND TOLERANCING PER ASME Y14.5M, 1994.
2. CONTROLLING DIMENSION: MILLIMETERS.
3. MAXIMUM LEAD THICKNESS INCLUDES LEAD FINISH. MINIMUM LEAD THICKNESS IS THE MINIMUM THICKNESS OF BASE MATERIAL.
4. DIMENSIONS D AND E DO NOT INCLUDE MOLD FLASH, PROTRUSIONS, OR GATE BURRS.

DIM	MILLIMETERS			INCHES		
	MIN	NOM	MAX	MIN	NOM	MAX
A	0.34	0.39	0.43	0.013	0.015	0.017
b	0.15	0.20	0.25	0.006	0.008	0.010
c	0.07	0.12	0.17	0.003	0.005	0.007
D	0.75	0.80	0.85	0.030	0.031	0.033
E	0.55	0.60	0.65	0.022	0.024	0.026
HE	0.95	1.00	1.05	0.037	0.039	0.041
L	0.19REF			0.007REF		
L2	0.05	0.10	0.15	0.002	0.004	0.006

7. SOLDERING FOOTPRINT

