

Common Cathode Silicon Dual Switching Diode

This Common Cathode Silicon Epitaxial Planar Dual Diode is designed for use in ultra high speed switching applications. This device is housed in the SC-89 package which is designed for low power surface mount applications, where board space is at a premium.

- Fast t_{rr}
- Low C_D
- Available in 8 mm Tape and Reel
- We declare that the material of product compliance with RoHS requirements.
- S- Prefix for Automotive and Other Applications Requiring Unique Site and Control Change Requirements; AEC-Q101 Qualified and PPAP Capable.

ORDERING INFORMATION

Device	Marking	Shipping
LDAN222T1G S-LDAN222T1G	N9	3000/Tape&Reel
LDAN222T3G S-LDAN222T3G	N9	10000/Tape&Reel

MAXIMUM RATINGS ($T_A = 25^\circ\text{C}$)

Rating	Symbol	Value	Unit
Reverse Voltage	V_R	80	Vdc
Peak Reverse Voltage	V_{RM}	80	Vdc
Forward Current	I_F	100	mAdc
Peak Forward Current	I_{FM}	300	mAdc
Peak Forward Surge Current	$I_{FSM}(1)$	2.0	Adc

THERMAL CHARACTERISTICS

Rating	Symbol	Max	Unit
Power Dissipation	P_D	150	mW
Junction Temperature	T_J	150	$^\circ\text{C}$
Storage Temperature Range	T_{stg}	-55 to +150	$^\circ\text{C}$

1. $t = 1 \mu\text{s}$

ELECTRICAL CHARACTERISTICS ($T_A = 25^\circ\text{C}$)

Characteristic	Symbol	Condition	Min	Max	Unit
Reverse Voltage Leakage Current	I_R	$V_R = 70 \text{ V}$	—	0.1	μAdc
Forward Voltage	V_F	$I_F = 100 \text{ mA}$	—	1.2	Vdc
Reverse Breakdown Voltage	V_R	$I_R = 100 \mu\text{A}$	80	—	Vdc
Diode Capacitance	C_D	$V_R = 6.0 \text{ V}, f = 1.0 \text{ MHz}$	—	3.5	pF
Reverse Recovery Time	$t_{rr}(2)$	$I_F = 5.0 \text{ mA}, V_R = 6.0 \text{ V}, R_L = 100 \Omega, I_{rr} = 0.1 I_R$	—	4.0	ns

2. t_{rr} Test Circuit on following page.

LDAN222T1G
S-LDAN222T1G

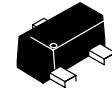

SC-89

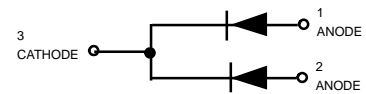

LDAN222T1G, S-LDAN222T1G

Electrical characteristic curves

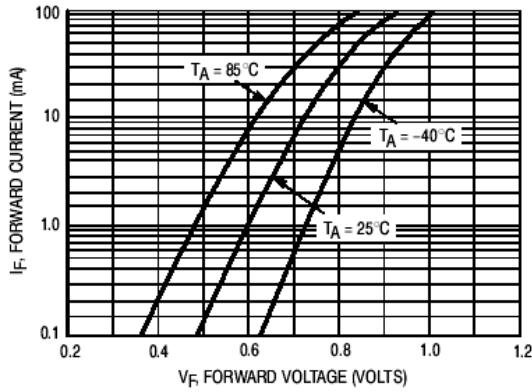

Figure 1. Forward Voltage

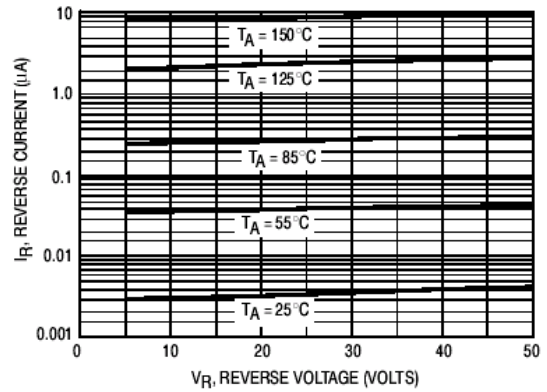

Figure 2. Reverse Current

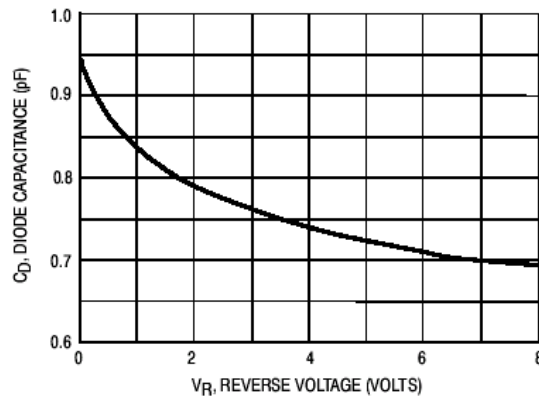
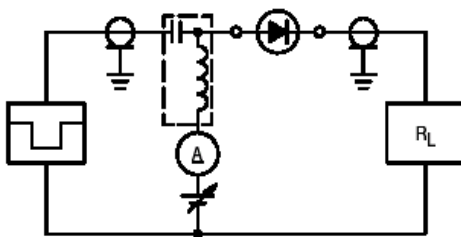
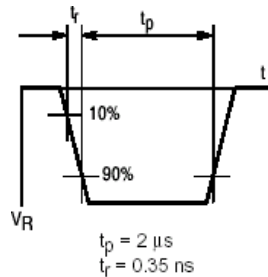

Figure 3. Diode Capacitance



RECOVERY TIME EQUIVALENT TEST CIRCUIT



INPUT PULSE

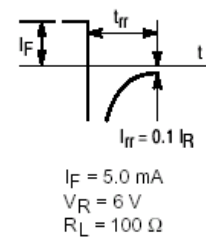

OUTPUT PULSE

LDAN222T1G, S-LDAN222T1G

SC-89

Dimension Outline:

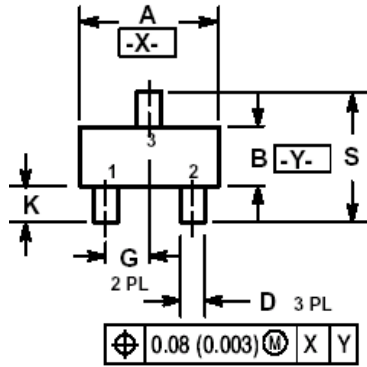

NOTES:

1. DIMENSIONING AND TOLERANCING PER ANSI Y14.5M 1982

DIM	MILLIMETERS			INCHES		
	MIN	NOM	MAX	MIN	NOM	MAX
A	1.50	1.60	1.70	0.059	0.063	0.067
B	0.75	0.85	0.95	0.030	0.034	0.040
C	0.60	0.70	0.80	0.024	0.028	0.031
D	0.23	0.28	0.33	0.009	0.011	0.013
G	0.50 BSC			0.020 BSC		
H	0.53 REF			0.021 REF		
J	0.10	0.15	0.20	0.004	0.006	0.008
K	0.30	0.40	0.50	0.012	0.016	0.020
L	1.10 REF			0.043 REF		
M	---	---	10 °	---	---	10 °
N	---	---	10 °	---	---	10 °
S	1.50	1.60	1.70	0.059	0.063	0.067

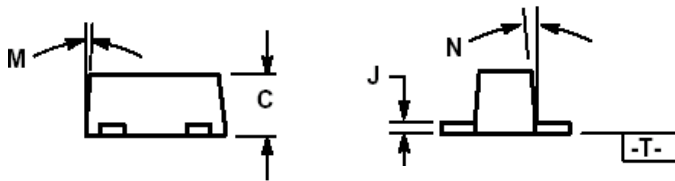

Soldering Footprint:

