

Bias Resistor Transistors

PNP Silicon Surface Mount Transistors with Monolithic Bias Resistor Network

This new series of digital transistors is designed to replace a single device and its external resistor bias network. The BRT (Bias Resistor Transistor) contains a single transistor with a monolithic bias network consisting of two resistors; a series base resistor and a base-emitter resistor. The BRT eliminates these individual components by integrating them into a single device. The use of a BRT can reduce both system cost and board space. The device is housed in the SOT-23 package which is designed for low power surface mount applications.

- Simplifies Circuit Design
- Reduces Board Space
- Reduces Component Count
- The SOT-23 package can be soldered using wave or reflow. The modified gull-winged leads absorb thermal stress during soldering eliminating the possibility of damage to the die.
- Available in 8 mm embossed tape and reel. Use the Device Number to order the 7 inch/3000 unit reel. Replace “T1” with “T3” in the Device Number to order the 13 inch/10,000 unit reel.
- We declare that the material of product compliance with RoHS requirements.

LMUN2111LT1G SERIES

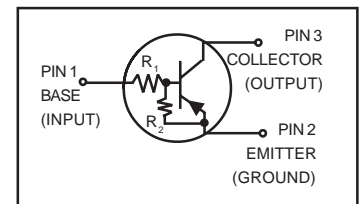

MAXIMUM RATINGS ($T_A = 25^\circ\text{C}$ unless otherwise noted)

| Rating | Symbol | Value | Unit |
|---------------------------|-----------|-------|------|
| Collector-Base Voltage | V_{CBO} | 50 | Vdc |
| Collector-Emitter Voltage | V_{CEO} | 50 | Vdc |
| Collector Current | I_C | 100 | mAdc |

THERMAL CHARACTERISTICS

| Characteristic | Symbol | Max | Unit |
|---|-----------------|--|---------------------------------|
| Total Device Dissipation $T_A = 25^\circ\text{C}$ Derate above 25°C | P_D | 246 (Note 1.) 400 (Note 2.) 1.5 (Note 1.) 2.0 (Note 2.) | mW $^\circ\text{C}/\text{W}$ |
| Thermal Resistance – Junction-to-Ambient | $R_{\theta JA}$ | 508 (Note 1.) 311 (Note 2.) | $^\circ\text{C}/\text{W}$ |
| Thermal Resistance – Junction-to-Lead | $R_{\theta JL}$ | 174 (Note 1.) 208 (Note 2.) | $^\circ\text{C}/\text{W}$ |
| Junction and Storage Temperature Range | T_J, T_{stg} | -55 to +150 | $^\circ\text{C}$ |

1. FR-4 @ Minimum Pad
2. FR-4 @ 1.0 x 1.0 inch Pad

LMUN2111LT1G Series

DEVICE MARKING AND RESISTOR VALUES

| Device | Package | Marking | R1 (K) | R2 (K) | Shipping |
|--|---------|---------|--------|--------|--|
| LMUN2110LT1G LMUN2110LT3G | SOT-23 | A6O | 47 | ∞ | 3000/Tape & Reel 10,000/Tape & Reel |
| LMUN2111LT1G LMUN2111LT3G | SOT-23 | A6A | 10 | 10 | 3000/Tape & Reel 10,000/Tape & Reel |
| LMUN2112LT1G LMUN2112LT3G | SOT-23 | A6B | 22 | 22 | 3000/Tape & Reel 10,000/Tape & Reel |
| LMUN2113LT1G LMUN2113LT3G | SOT-23 | A6C | 47 | 47 | 3000/Tape & Reel 10,000/Tape & Reel |
| LMUN2114LT1G LMUN2114LT3G | SOT-23 | A6D | 10 | 47 | 3000/Tape & Reel 10,000/Tape & Reel |
| LMUN2115LT1G (Note 3.) LMUN2115LT3G | SOT-23 | A6E | 10 | ∞ | 3000/Tape & Reel 10,000/Tape & Reel |
| LMUN2116LT1G (Note 3.) LMUN2116LT3G | SOT-23 | A6F | 4.7 | ∞ | 3000/Tape & Reel 10,000/Tape & Reel |
| LMUN2130LT1G (Note 3.) LMUN2130LT3G | SOT-23 | A6G | 1.0 | 1.0 | 3000/Tape & Reel 10,000/Tape & Reel |
| LMUN2131LT1G (Note 3.) LMUN2131LT3G | SOT-23 | A6H | 2.2 | 2.2 | 3000/Tape & Reel 10,000/Tape & Reel |
| LMUN2132LT1G (Note 3.) LMUN2132LT3G | SOT-23 | A6J | 4.7 | 4.7 | 3000/Tape & Reel 10,000/Tape & Reel |
| LMUN2133LT1G (Note 3.) LMUN2133LT3G | SOT-23 | A6K | 4.7 | 47 | 3000/Tape & Reel 10,000/Tape & Reel |
| LMUN2134LT1G (Note 3.) LMUN2134LT3G | SOT-23 | A6L | 22 | 47 | 3000/Tape & Reel 10,000/Tape & Reel |

ELECTRICAL CHARACTERISTICS ($T_A = 25^\circ\text{C}$ unless otherwise noted)

| Characteristic | Symbol | Min | Typ | Max | Unit |
|----------------|--------|-----|-----|-----|------|
|----------------|--------|-----|-----|-----|------|

OFF CHARACTERISTICS

| | | | | | |
|--|---------------|----|---|------|------|
| Collector-Base Cutoff Current ($V_{CB} = 50\text{ V}$, $I_E = 0$) | I_{CBO} | – | – | 100 | nAdc |
| Collector-Emitter Cutoff Current ($V_{CE} = 50\text{ V}$, $I_B = 0$) | I_{CEO} | – | – | 500 | nAdc |
| Emitter-Base Cutoff Current ($V_{EB} = 6.0\text{ V}$, $I_C = 0$) | I_{EBO} | – | – | 0.1 | mAdc |
| LMUN2110LT1G | | – | – | 0.5 | |
| LMUN2111LT1G | | – | – | 0.2 | |
| LMUN2112LT1G | | – | – | 0.1 | |
| LMUN2113LT1G | | – | – | 0.2 | |
| LMUN2114LT1G | | – | – | 0.9 | |
| LMUN2115LT1G | | – | – | 1.9 | |
| LMUN2130LT1G | | – | – | 4.3 | |
| LMUN2131LT1G | | – | – | 2.3 | |
| LMUN2132LT1G | | – | – | 1.5 | |
| LMUN2133LT1G | | – | – | 0.18 | |
| LMUN2134LT1G | | – | – | 0.13 | |
| Collector-Base Breakdown Voltage ($I_C = 10\ \mu\text{A}$, $I_E = 0$) | $V_{(BR)CBO}$ | 50 | – | – | Vdc |
| Collector-Emitter Breakdown Voltage (Note 4.) ($I_C = 2.0\text{ mA}$, $I_B = 0$) | $V_{(BR)CEO}$ | 50 | – | – | Vdc |

3. New devices. Updated curves to follow in subsequent data sheets.

4. Pulse Test: Pulse Width < 300 μs , Duty Cycle < 2.0%

LMUN2111LT1G Series

ELECTRICAL CHARACTERISTICS ($T_A = 25^\circ\text{C}$ unless otherwise noted) (Continued)

| Characteristic | Symbol | Min | Typ | Max | Unit | |
|---|--|---------------|--|---|--|------------|
| ON CHARACTERISTICS (Note 5.) | | | | | | |
| DC Current Gain ($V_{CE} = 10\text{ V}$, $I_C = 5.0\text{ mA}$) | LMUN2110LT1G LMUN2111LT1G LMUN2112LT1G LMUN2113LT1G LMUN2114LT1G LMUN2115LT1G LMUN2116LT1G LMUN2130LT1G LMUN2131LT1G LMUN2132LT1G LMUN2133LT1G LMUN2134LT1G | h_{FE} | 80 35 60 80 80 160 160 3.0 8.0 15 80 80 | 140 60 100 140 140 250 250 5.0 15 27 140 130 | – – – – – – – – – – – – | |
| Collector-Emitter Saturation Voltage ($I_C = 10\text{ mA}$, $I_B = 0.3\text{ mA}$) ($I_C = 10\text{ mA}$, $I_B = 5\text{ mA}$) LMUN2130LT1G/LMUN2131LT1G ($I_C = 10\text{ mA}$, $I_B = 1\text{ mA}$) LMUN2115LT1G/LMUN2116LT1G/ LMUN2132LT1G/LMUN2133LT1G/LMUN2134LT1G | | $V_{CE(sat)}$ | – | – | 0.25 | Vdc |
| Output Voltage (on) ($V_{CC} = 5.0\text{ V}$, $V_B = 2.5\text{ V}$, $R_L = 1.0\text{ k}\Omega$) ($V_{CC} = 5.0\text{ V}$, $V_B = 3.5\text{ V}$, $R_L = 1.0\text{ k}\Omega$) | LMUN2110LT1G LMUN2114LT1G LMUN2111LT1G LMUN2112LT1G LMUN2114LT1G LMUN2115LT1G LMUN2116LT1G LMUN2130LT1G LMUN2131LT1G LMUN2132LT1G LMUN2133LT1G LMUN2134LT1G LMUN2113LT1G | V_{OL} | – – – – – – – – – – – – – – | – – – – – – – – – – – – – – | 0.2 0.2 0.2 0.2 0.2 0.2 0.2 0.2 0.2 0.2 0.2 0.2 0.2 0.2 | Vdc |
| Output Voltage (off) ($V_{CC} = 5.0\text{ V}$, $V_B = 0.5\text{ V}$, $R_L = 1.0\text{ k}\Omega$) ($V_{CC} = 5.0\text{ V}$, $V_B = 0.25\text{ V}$, $R_L = 1.0\text{ k}\Omega$) ($V_{CC} = 5.0\text{ V}$, $V_B = 0.050\text{ V}$, $R_L = 1.0\text{ k}\Omega$) | LMUN2115LT1G LMUN2116LT1G LMUN2131LT1G LMUN2132LT1G LMUN2130LT1G | V_{OH} | 4.9 | – | – | Vdc |
| Input Resistor | LMUN2110LT1G LMUN2111LT1G LMUN2112LT1G LMUN2113LT1G LMUN2114LT1G LMUN2115LT1G LMUN2116LT1G LMUN2130LT1G LMUN2131LT1G LMUN2132LT1G LMUN2133LT1G LMUN2134LT1G | R_1 | 32.9 7.0 15.4 32.9 7.0 7.0 3.3 0.7 1.5 3.3 3.3 15.4 | 47 10 22 47 10 10 4.7 1.0 2.2 4.7 4.7 22 | 61.1 13 28.6 61.1 13 13 6.1 1.3 2.9 6.1 6.1 28.6 | k Ω |
| Resistor Ratio | LMUN2111LT1G/LMUN2112LT1G/LMUN2113LT1G LMUN2114LT1G LMUN2115LT1G/LMUN2116LT1G/LMUN2110LT1G LMUN2130LT1G/LMUN2131LT1G/LMUN2132LT1G LMUN2133LT1G | R_1/R_2 | 0.8 0.17 – 0.8 0.055 | 1.0 0.21 – 1.0 0.1 | 1.2 0.25 – 1.2 0.185 | |

5. Pulse Test: Pulse Width < 300 μs , Duty Cycle < 2.0%

LMUN2111LT1G Series

TYPICAL ELECTRICAL CHARACTERISTICS
LMUN2111LT1G

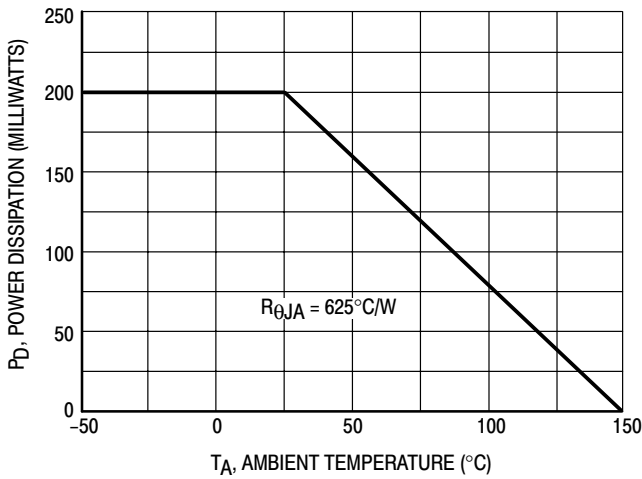

Figure 1. Derating Curve

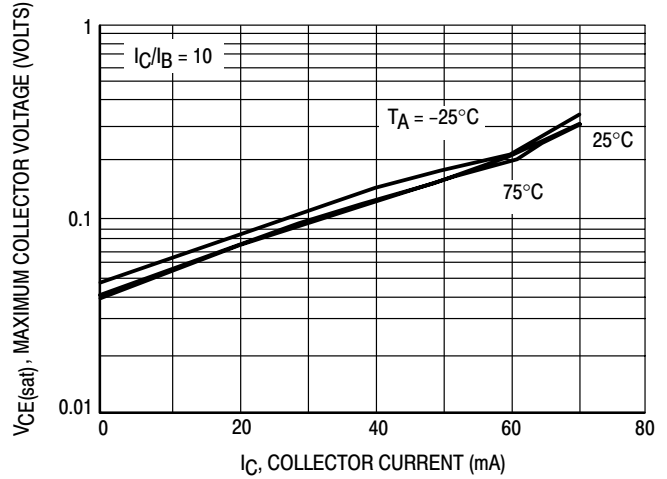

Figure 2. $V_{CE(sat)}$ versus I_C



Figure 3. DC Current Gain

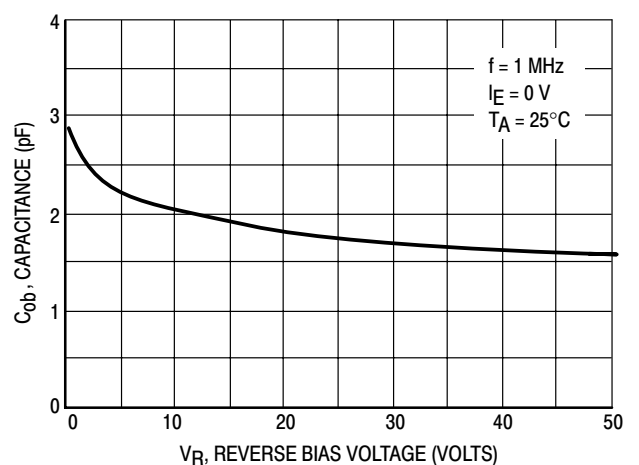

Figure 4. Output Capacitance

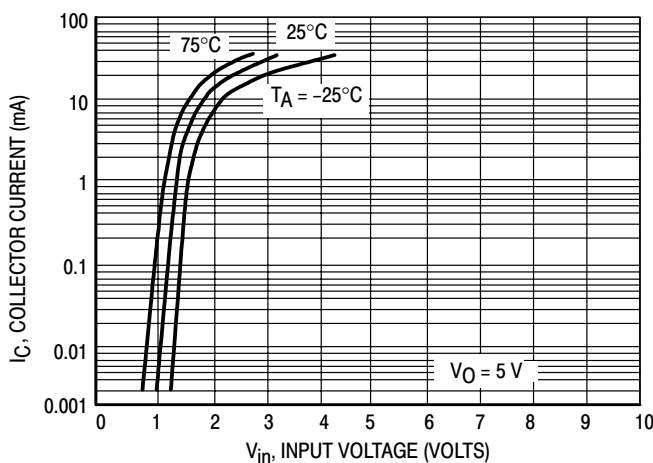

Figure 5. Output Current versus Input Voltage

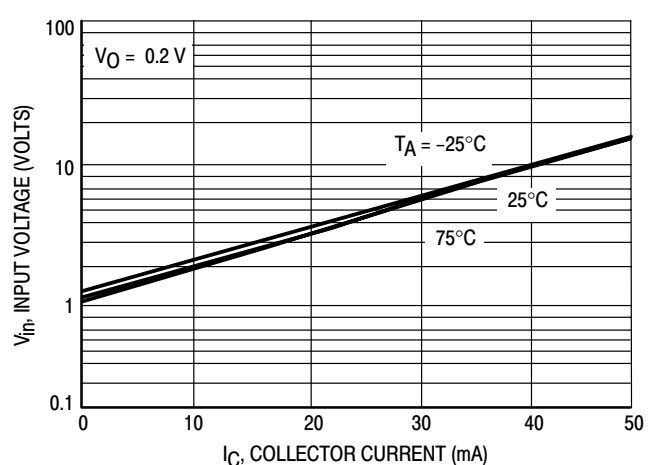

Figure 6. Input Voltage versus Output Current

LMUN2111LT1G Series

TYPICAL ELECTRICAL CHARACTERISTICS
LMUN2112LT1G

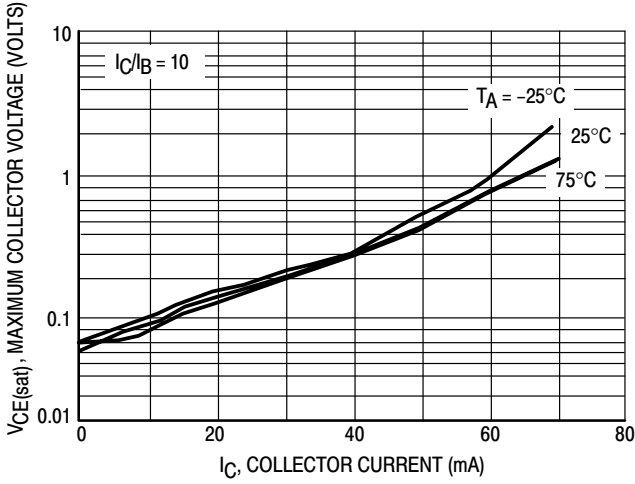

Figure 7. $V_{CE(sat)}$ versus I_C

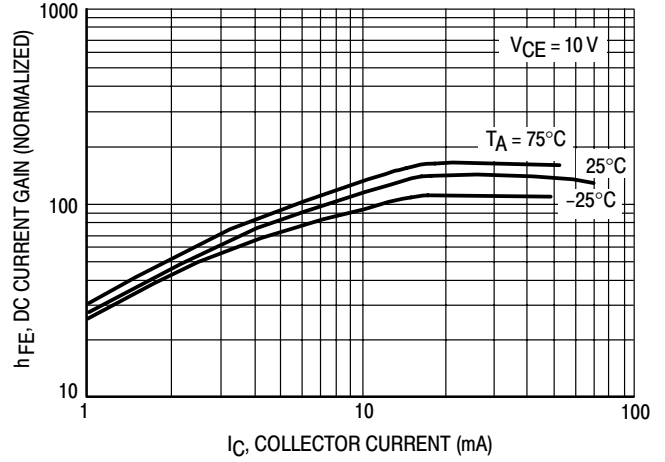

Figure 8. DC Current Gain

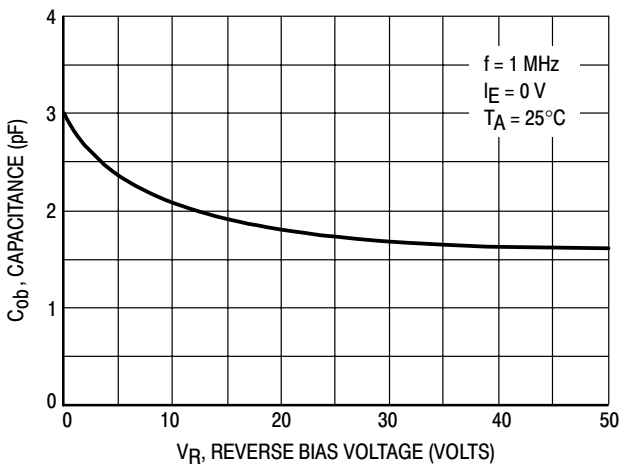

Figure 9. Output Capacitance

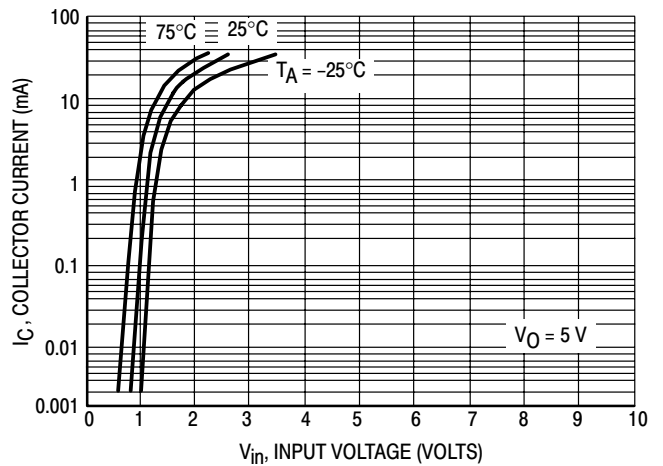

Figure 10. Output Current versus Input Voltage



Figure 11. Input Voltage versus Output Current

LMUN2111LT1G Series

TYPICAL ELECTRICAL CHARACTERISTICS
LMUN2113LT1G

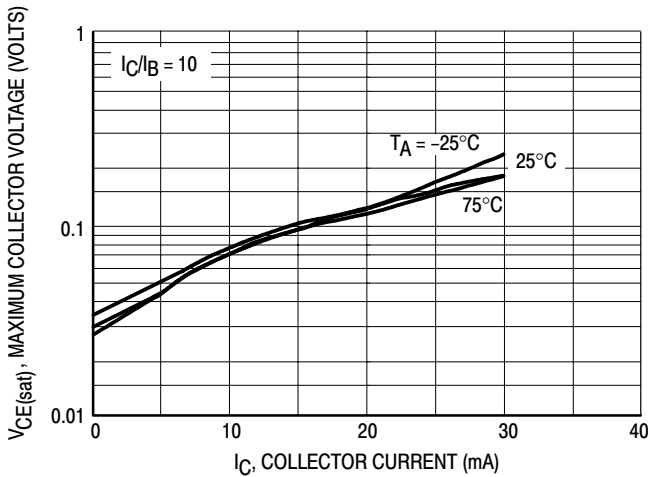

Figure 12. $V_{CE(sat)}$ versus I_C

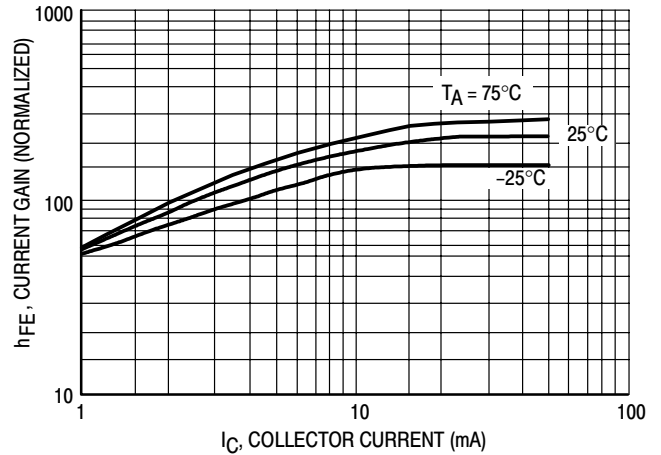

Figure 13. DC Current Gain

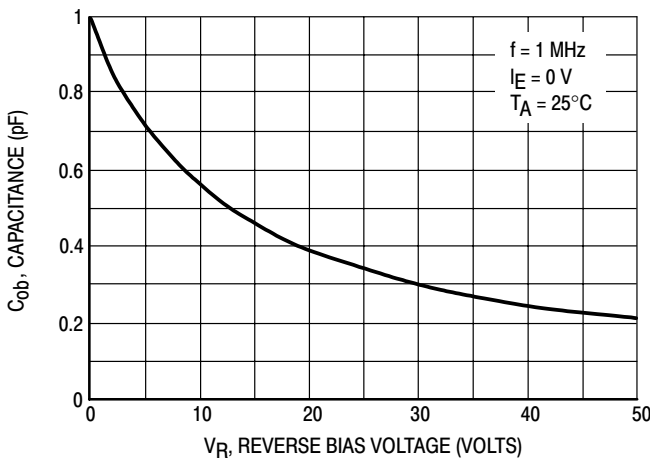

Figure 14. Output Capacitance

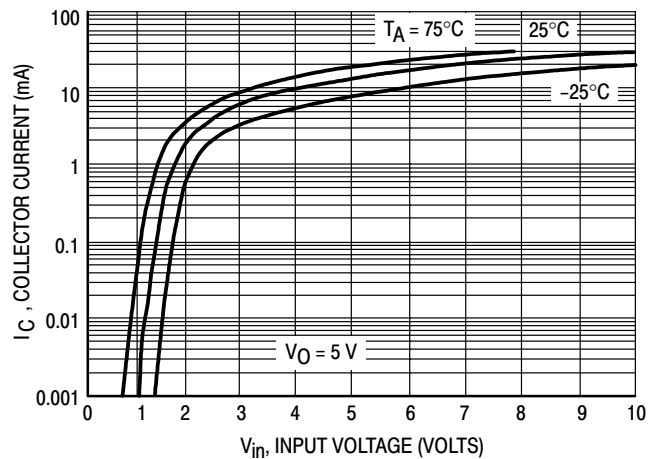

Figure 15. Output Current versus Input Voltage



Figure 16. Input Voltage versus Output Current

LMUN2111LT1G Series

TYPICAL ELECTRICAL CHARACTERISTICS
LMUN2114LT1G



Figure 17. $V_{CE(sat)}$ versus I_C



Figure 18. DC Current Gain

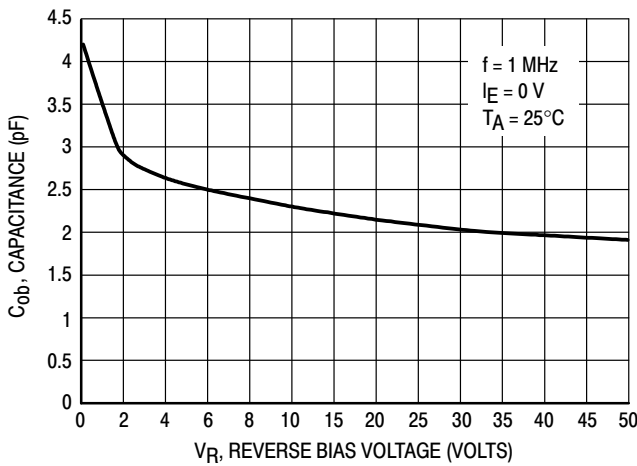

Figure 19. Output Capacitance

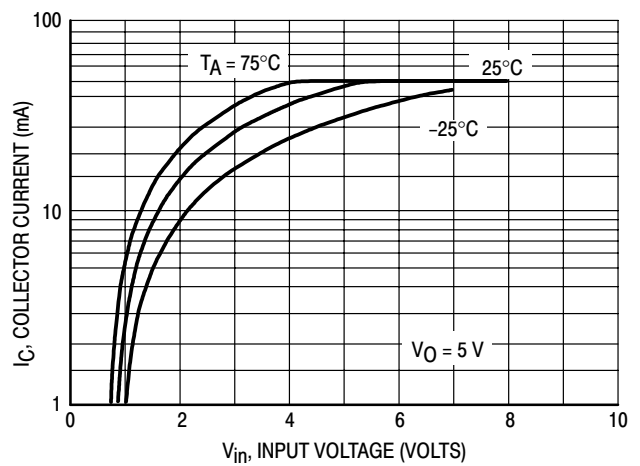

Figure 20. Output Current versus Input Voltage

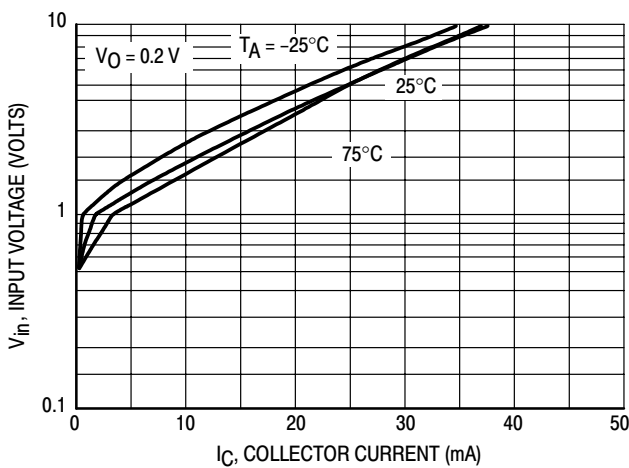

Figure 21. Input Voltage versus Output Current

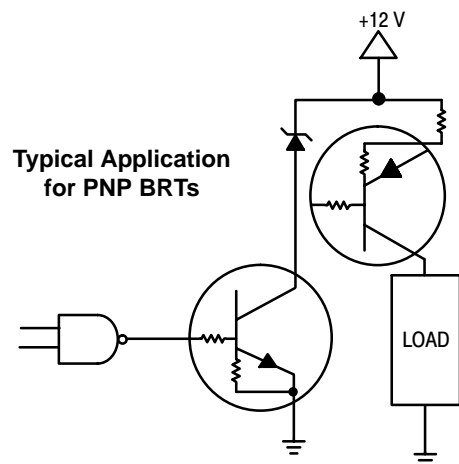
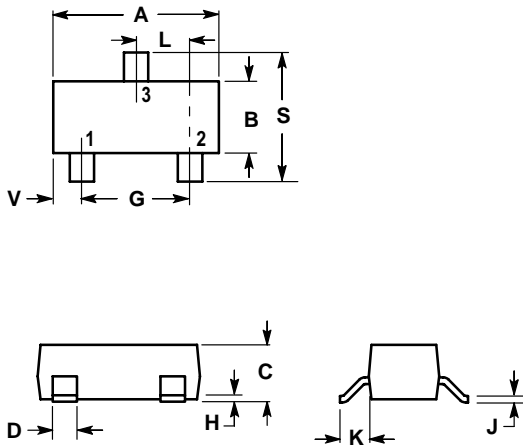

Figure 22. Inexpensive, Unregulated Current Source

LMUN2111LT1G Series

SOT-23



NOTES:

1. DIMENSIONING AND TOLERANCING PER ANSI Y14.5M, 1982.
2. CONTROLLING DIMENSION: INCH.

| DIM | INCHES | | MILLIMETERS | |
|-----|--------|--------|-------------|-------|
| | MIN | MAX | MIN | MAX |
| A | 0.1102 | 0.1197 | 2.80 | 3.04 |
| B | 0.0472 | 0.0551 | 1.20 | 1.40 |
| C | 0.0350 | 0.0440 | 0.89 | 1.11 |
| D | 0.0150 | 0.0200 | 0.37 | 0.50 |
| G | 0.0701 | 0.0807 | 1.78 | 2.04 |
| H | 0.0005 | 0.0040 | 0.013 | 0.100 |
| J | 0.0034 | 0.0070 | 0.085 | 0.177 |
| K | 0.0140 | 0.0285 | 0.35 | 0.69 |
| L | 0.0350 | 0.0401 | 0.89 | 1.02 |
| S | 0.0830 | 0.1039 | 2.10 | 2.64 |
| V | 0.0177 | 0.0236 | 0.45 | 0.60 |

- PIN 1. BASE
 2. EMITTER
 3. COLLECTOR

