

Bias Resistor Transistor

NPN Silicon Surface Mount Transistor with Monolithic Bias Resistor Network

This new series of digital transistors is designed to replace a single device and its external resistor bias network. The BRT (Bias Resistor Transistor) contains a single transistor with a monolithic bias network

resistor. The BRT eliminates these individual components by integrating them into a single device. The use of a BRT can reduce both system cost and board space. The device is housed in the SOT-23 package which is designed for low power surface mount applications.

- Simplifies Circuit Design
- Reduces Board Space and Component Count
- The SOT-23 package can be soldered using wave or reflow. The modified gull-winged leads absorb thermal stress during soldering eliminating the possibility of damage to the die.
- Available in 8 mm embossed tape and reel. Use the Device Number to order the 7 inch/3000 unit reel. Replace “T1” with “T3” in the Device Number to order the 13 inch/10,000 unit reel.

MAXIMUM RATINGS (T_A = 25°C unless otherwise noted)

| Rating | Symbol | Value | Unit |
|--|------------------|------------|------------|
| Collector-Base Voltage | V _{CBO} | 50 | Vdc |
| Collector-Emitter Voltage | V _{CEO} | 50 | Vdc |
| Collector Current | I _C | 100 | mAdc |
| Total Power Dissipation @ T _A = 25°C (Note 1.) Derate above 25°C | P _D | 246 1.5 | mW °C/W |

DEVICE MARKING AND RESISTOR VALUES

| Device | Marking | R1(K) | R2(K) |
|--------------|---------|-------|-------|
| LMUN2211LT1G | A8A | 10 | 10 |
| LMUN2212LT1G | A8B | 22 | 22 |
| LMUN2213LT1G | A8C | 47 | 47 |
| LMUN2214LT1G | A8D | 10 | 47 |
| LMUN2215LT1G | A8E | 10 | ∞ |
| LMUN2216LT1G | A8F | 4.7 | ∞ |
| LMUN2230LT1G | A8G | 1.0 | 1.0 |
| LMUN2231LT1G | A8H | 2.2 | 2.2 |
| LMUN2232LT1G | A8J | 4.7 | 4.7 |
| LMUN2233LT1G | A8K | 4.7 | 47 |
| LMUN2234LT1G | A8L | 22 | 47 |
| LMUN2235LT1G | A8M | 2.2 | 47 |
| LMUN2238LT1G | A8R | 2.2 | ∞ |
| LMUN2241LT1G | A8U | 100 | ∞ |

1. Device mounted on a FR-4 glass epoxy printed circuit board using the minimum recommended footprint.

LMUN2211LT1G SERIES

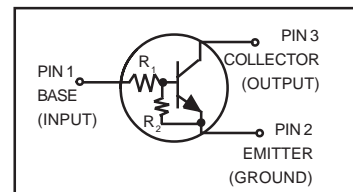

We declare that the material of product compliance with RoHS requirements.

Ordering Information

| Device | Package | Shipping |
|--------------|---------|-----------------|
| LMUN22XXLT1G | SOT23 | 3000/Tape&Reel |
| LMUN22XXLT3G | SOT23 | 10000/Tape&Reel |

ORDERING INFORMATION

| Device | Package | Shipping |
|--------------|---------|------------------|
| LMUN2211LT1G | SOT-23 | 3000/Tape & Reel |
| LMUN2212LT1G | SOT-23 | 3000/Tape & Reel |
| LMUN2213LT1G | SOT-23 | 3000/Tape & Reel |
| LMUN2214LT1G | SOT-23 | 3000/Tape & Reel |
| LMUN2215LT1G | SOT-23 | 3000/Tape & Reel |
| LMUN2216LT1G | SOT-23 | 3000/Tape & Reel |
| LMUN2230LT1G | SOT-23 | 3000/Tape & Reel |
| LMUN2231LT1G | SOT-23 | 3000/Tape & Reel |
| LMUN2232LT1G | SOT-23 | 3000/Tape & Reel |
| LMUN2233LT1G | SOT-23 | 3000/Tape & Reel |
| LMUN2234LT1G | SOT-23 | 3000/Tape & Reel |
| LMUN2235LT1G | SOT-23 | 3000/Tape & Reel |
| LMUN2238LT1G | SOT-23 | 3000/Tape & Reel |
| LMUN2241LT1G | SOT-23 | 3000/Tape & Reel |

LMUN2211LT1G Series

THERMAL CHARACTERISTICS

| Rating | Symbol | Value | Unit |
|--|-----------------|-------------|-----------|
| Thermal Resistance – Junction-to-Ambient (Note 1.) | $R_{\theta JA}$ | 508 | °C/W |
| Operating and Storage Temperature Range | T_J, T_{stg} | -55 to +150 | °C |
| Maximum Temperature for Soldering Purposes, Time in Solder Bath | T_L | 260 10 | °C Sec |

ELECTRICAL CHARACTERISTICS ($T_A = 25^\circ\text{C}$ unless otherwise noted)

| Characteristic | Symbol | Min | Typ | Max | Unit |
|----------------|--------|-----|-----|-----|------|
|----------------|--------|-----|-----|-----|------|

OFF CHARACTERISTICS

| | | | | | |
|---|---------------|----|---|------|------|
| Collector-Base Cutoff Current ($V_{CB} = 50\text{ V}, I_E = 0$) | I_{CBO} | – | – | 100 | nAdc |
| Collector-Emitter Cutoff Current ($V_{CE} = 50\text{ V}, I_B = 0$) | I_{CEO} | – | – | 500 | nAdc |
| Emitter-Base Cutoff Current ($V_{EB} = 6.0\text{ V}, I_C = 0$) | I_{EBO} | – | – | 0.5 | mAdc |
| LMUN2211LT1G | | – | – | 0.2 | |
| LMUN2212LT1G | | – | – | 0.1 | |
| LMUN2213LT1G | | – | – | 0.2 | |
| LMUN2214LT1G | | – | – | 0.9 | |
| LMUN2215LT1G | | – | – | 1.9 | |
| LMUN2216LT1G | | – | – | 4.3 | |
| LMUN2230LT1G | | – | – | 2.3 | |
| LMUN2231LT1G | | – | – | 1.5 | |
| LMUN2232LT1G | | – | – | 0.18 | |
| LMUN2233LT1G | | – | – | 0.13 | |
| LMUN2234LT1G | | – | – | 0.2 | |
| LMUN2235LT1G | | – | – | 4.0 | |
| LMUN2238LT1G | | – | – | 0.1 | |
| LMUN2241LT1G | | – | – | | |
| Collector-Base Breakdown Voltage ($I_C = 10\ \mu\text{A}, I_E = 0$) | $V_{(BR)CBO}$ | 50 | – | – | Vdc |
| Collector-Emitter Breakdown Voltage (Note 2.), ($I_C = 2.0\text{ mA}, I_B = 0$) | $V_{(BR)CEO}$ | 50 | – | – | Vdc |

ON CHARACTERISTICS (Note 2.)

| | | | | | |
|--|---------------|-----|-----|------|-----|
| DC Current Gain ($V_{CE} = 10\text{ V}, I_C = 5.0\text{ mA}$) | h_{FE} | 35 | 60 | – | |
| LMUN2211LT1G | | 60 | 100 | – | |
| LMUN2212LT1G | | 80 | 140 | – | |
| LMUN2213LT1G | | 80 | 140 | – | |
| LMUN2214LT1G | | 160 | 350 | – | |
| LMUN2215LT1G | | 160 | 350 | – | |
| LMUN2216LT1G | | 3.0 | 5.0 | – | |
| LMUN2230LT1G | | 8.0 | 15 | – | |
| LMUN2231LT1G | | 15 | 30 | – | |
| LMUN2232LT1G | | 80 | 200 | – | |
| LMUN2233LT1G | | 80 | 150 | – | |
| LMUN2234LT1G | | 80 | 140 | – | |
| LMUN2235LT1G | | 160 | 350 | – | |
| LMUN2238LT1G | | 160 | 350 | – | |
| LMUN2241LT1G | | | | – | |
| Collector-Emitter Saturation Voltage ($I_C = 10\text{ mA}, I_B = 0.3\text{ mA}$) ($I_C = 10\text{ mA}, I_B = 5\text{ mA}$) LMUN2230LT1G/LMUN2231LT1G ($I_C = 10\text{ mA}, I_B = 1\text{ mA}$) LMUN2215LT1G/LMUN2216LT1G LMUN2232LT1G/LMUN2233LT1G/LMUN2234LT1G/ LMUN2235LT1G/LMUN2238LT1G | $V_{CE(sat)}$ | – | – | 0.25 | Vdc |

2. Pulse Test: Pulse Width < 300 μs , Duty Cycle < 2.0%.

LMUN2211LT1G Series

ELECTRICAL CHARACTERISTICS ($T_A = 25^\circ\text{C}$ unless otherwise noted) (Continued)

| Characteristic | Symbol | Min | Typ | Max | Unit |
|--|-----------|-------|-------|-------|------------------|
| ON CHARACTERISTICS (Note 3.) | | | | | |
| Output Voltage (on) ($V_{CC} = 5.0\text{ V}$, $V_B = 2.5\text{ V}$, $R_L = 1.0\text{ k}\Omega$) | V_{OL} | – | – | 0.2 | Vdc |
| LMUN2211LT1G | | – | – | 0.2 | |
| LMUN2212LT1G | | – | – | 0.2 | |
| LMUN2214LT1G | | – | – | 0.2 | |
| LMUN2215LT1G | | – | – | 0.2 | |
| LMUN2216LT1G | | – | – | 0.2 | |
| LMUN2230LT1G | | – | – | 0.2 | |
| LMUN2231LT1G | | – | – | 0.2 | |
| LMUN2232LT1G | | – | – | 0.2 | |
| LMUN2233LT1G | | – | – | 0.2 | |
| LMUN2234LT1G | | – | – | 0.2 | |
| LMUN2235LT1G | | – | – | 0.2 | |
| LMUN2238LT1G | | – | – | 0.2 | |
| ($V_{CC} = 5.0\text{ V}$, $V_B = 3.5\text{ V}$, $R_L = 1.0\text{ k}\Omega$) | | – | – | 0.2 | |
| ($V_{CC} = 5.0\text{ V}$, $V_B = 5.0\text{ V}$, $R_L = 1.0\text{ k}\Omega$) | | – | – | 0.2 | |
| LMUN2213LT1G | | – | – | 0.2 | |
| LMUN2241LT1G | | – | – | 0.2 | |
| Output Voltage (off) ($V_{CC} = 5.0\text{ V}$, $V_B = 0.5\text{ V}$, $R_L = 1.0\text{ k}\Omega$) | V_{OH} | 4.9 | – | – | Vdc |
| ($V_{CC} = 5.0\text{ V}$, $V_B = 0.050\text{ V}$, $R_L = 1.0\text{ k}\Omega$) | | | | | |
| ($V_{CC} = 5.0\text{ V}$, $V_B = 0.25\text{ V}$, $R_L = 1.0\text{ k}\Omega$) | | | | | |
| LMUN2230LT1G | | | | | |
| LMUN2215LT1G | | | | | |
| LMUN2216LT1G | | | | | |
| LMUN2233LT1G | | | | | |
| LMUN2238LT1G | | | | | |
| Input Resistor | R_1 | 7.0 | 10 | 13 | $\text{k}\Omega$ |
| LMUN2211LT1G | | 15.4 | 22 | 28.6 | |
| LMUN2212LT1G | | 32.9 | 47 | 61.1 | |
| LMUN2213LT1G | | 7.0 | 10 | 13 | |
| LMUN2214LT1G | | 7.0 | 10 | 13 | |
| LMUN2215LT1G | | 3.3 | 4.7 | 6.1 | |
| LMUN2216LT1G | | 0.7 | 1.0 | 1.3 | |
| LMUN2230LT1G | | 1.5 | 2.2 | 2.9 | |
| LMUN2231LT1G | | 3.3 | 4.7 | 6.1 | |
| LMUN2232LT1G | | 3.3 | 4.7 | 6.1 | |
| LMUN2233LT1G | | 15.4 | 22 | 28.6 | |
| LMUN2234LT1G | | 1.54 | 2.2 | 2.86 | |
| LMUN2235LT1G | | 1.54 | 2.2 | 2.88 | |
| LMUN2238LT1G | | 70 | 100 | 130 | |
| LMUN2241LT1G | | | | | |
| Resistor Ratio | R_1/R_2 | 0.8 | 1.0 | 1.2 | |
| LMUN2211LT1G/LMUN2212LT1G/LMUN2213LT1G | | 0.17 | 0.21 | 0.25 | |
| LMUN2214LT1G | | – | – | – | |
| LMUN2215LT1G/LMUN2216LT1G/LMUN2238LT1G | | – | – | – | |
| LMUN2241LT1G | | – | – | – | |
| LMUN2230LT1G/LMUN2231LT1G/LMUN2232LT1G | | 0.8 | 1.0 | 1.2 | |
| LMUN2233LT1G | | 0.055 | 0.1 | 0.185 | |
| LMUN2234LT1G | | 0.38 | 0.47 | 0.56 | |
| LMUN2235LT1G | | 0.038 | 0.047 | 0.056 | |

3. Pulse Test: Pulse Width < 300 μs , Duty Cycle < 2.0%.

LMUN2211LT1G Series

TYPICAL ELECTRICAL CHARACTERISTICS
LMUN2211LT1G

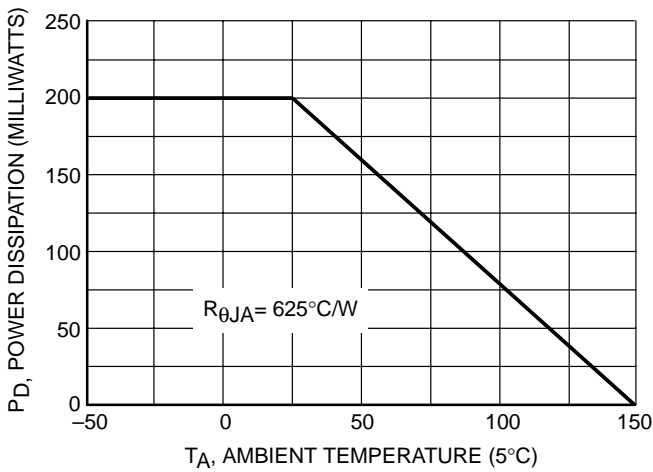

Figure 1. Derating Curve

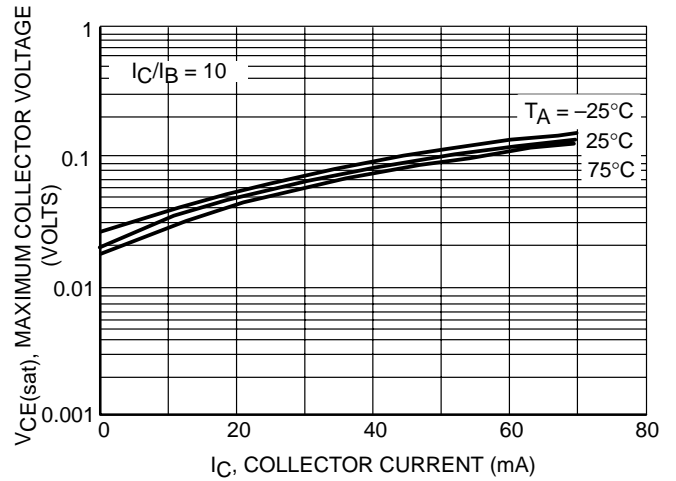

Figure 2. $V_{CE(sat)}$ vs. I_C

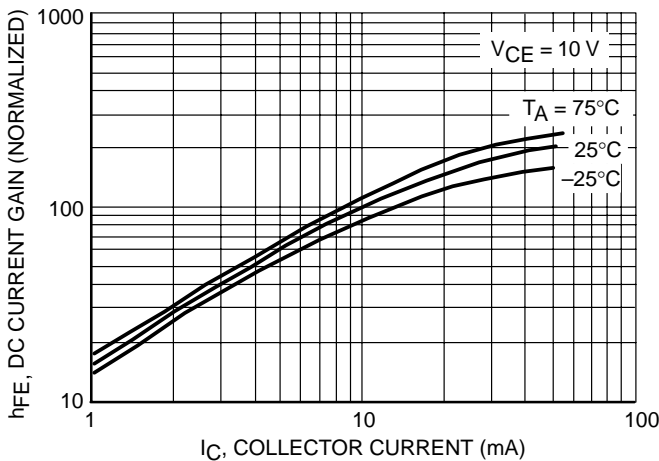

Figure 3. DC Current Gain

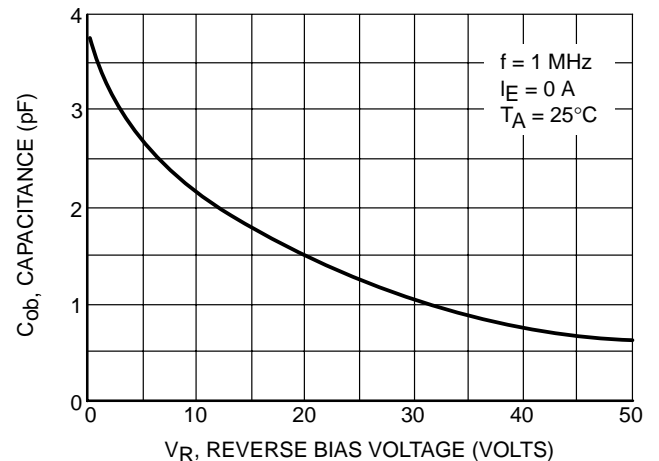

Figure 4. Output Capacitance

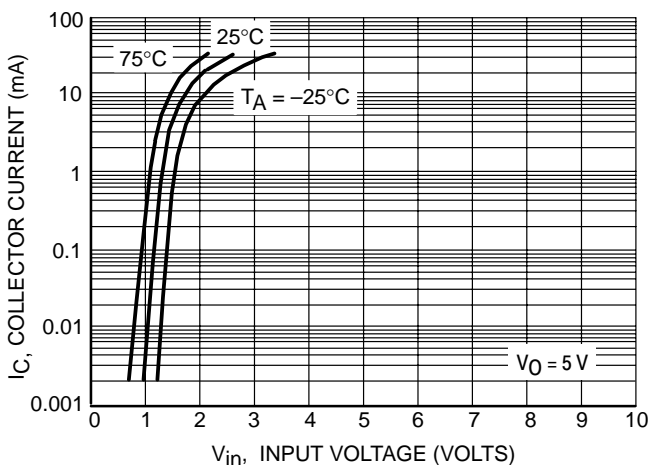

Figure 5. Output Current vs. Input Voltage

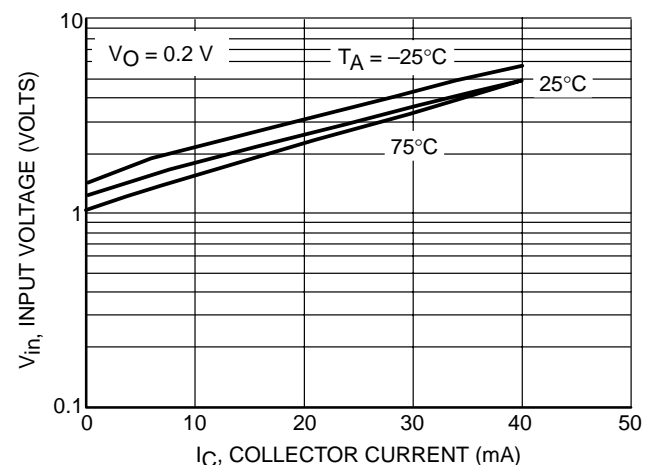

Figure 6. Input Voltage vs. Output Current

LMUN2211LT1G Series

TYPICAL ELECTRICAL CHARACTERISTICS
LMUN2212LT1G

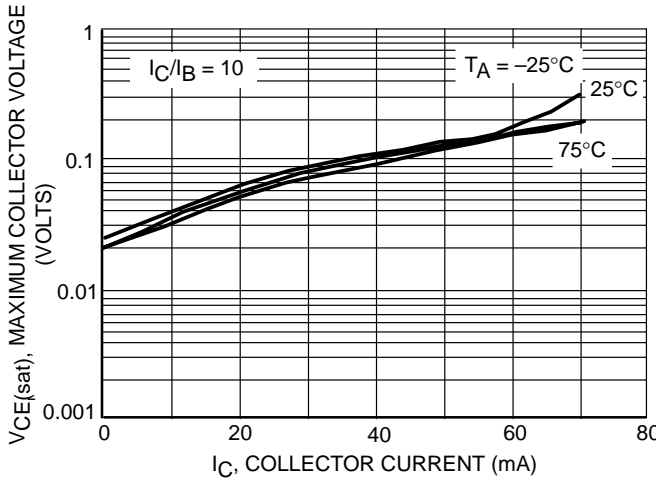

Figure 7. $V_{CE(sat)}$ vs. I_C

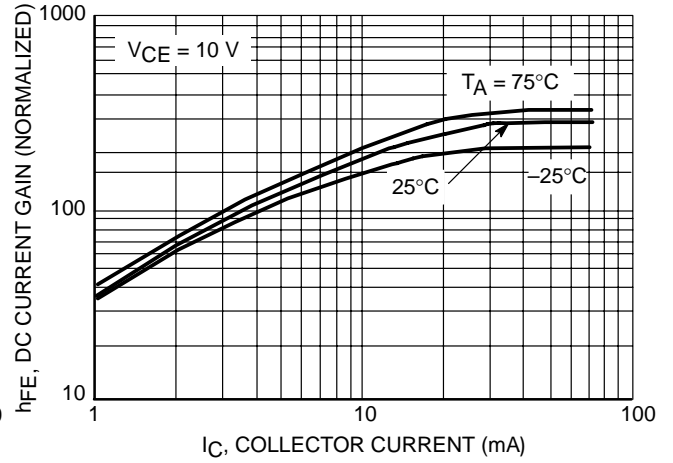

Figure 8. DC Current Gain

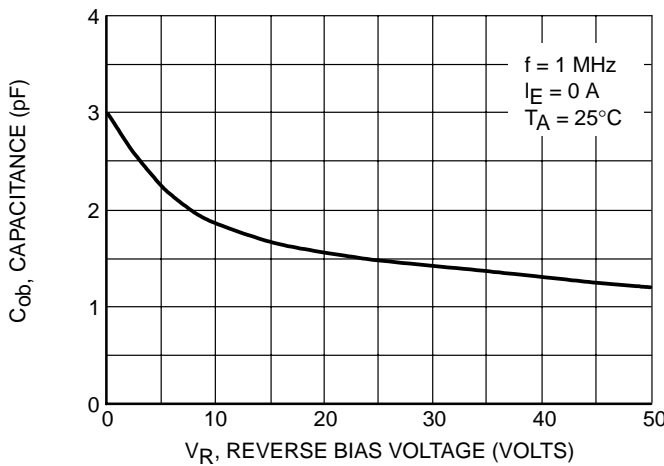

Figure 9. Output Capacitance

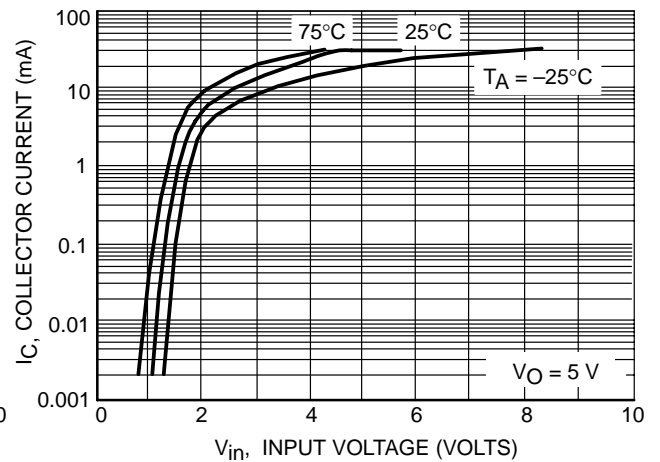

Figure 10. Output Current vs. Input Voltage

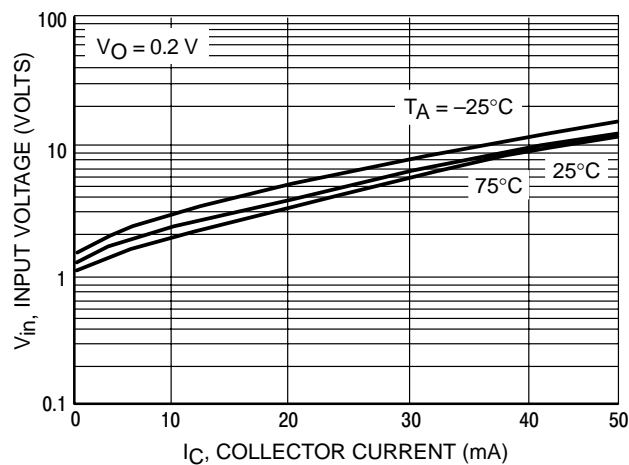

Figure 11. Input Voltage vs. Output Current

LMUN2211LT1G Series

TYPICAL ELECTRICAL CHARACTERISTICS
LMUN2213LT1G

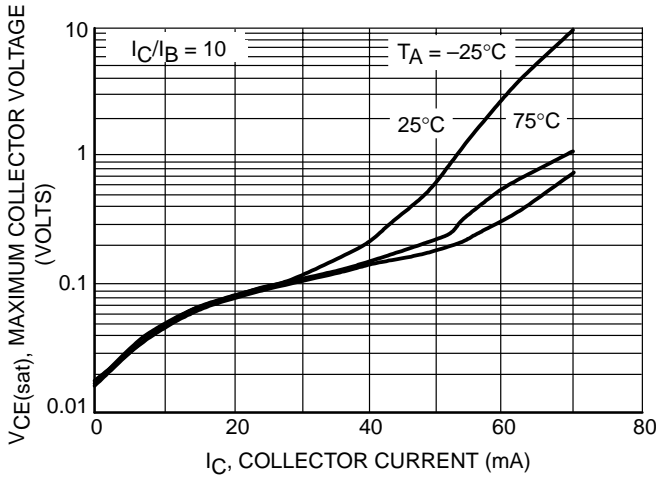

Figure 12. $V_{CE(sat)}$ vs. I_C

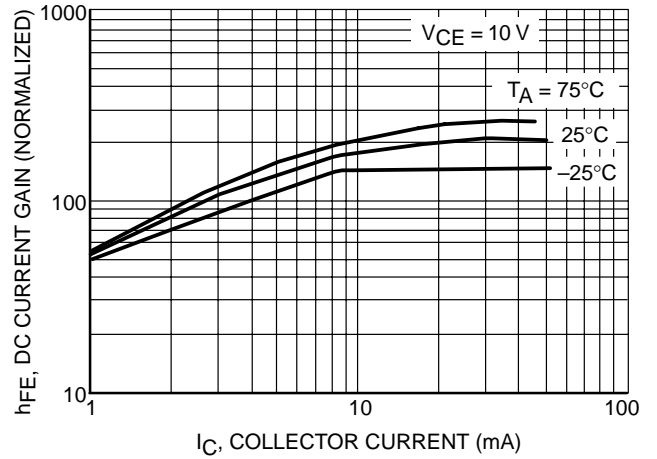

Figure 13. DC Current Gain

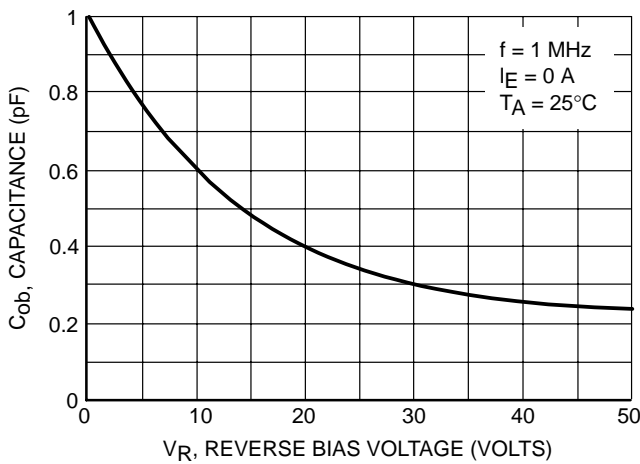

Figure 14. Output Capacitance

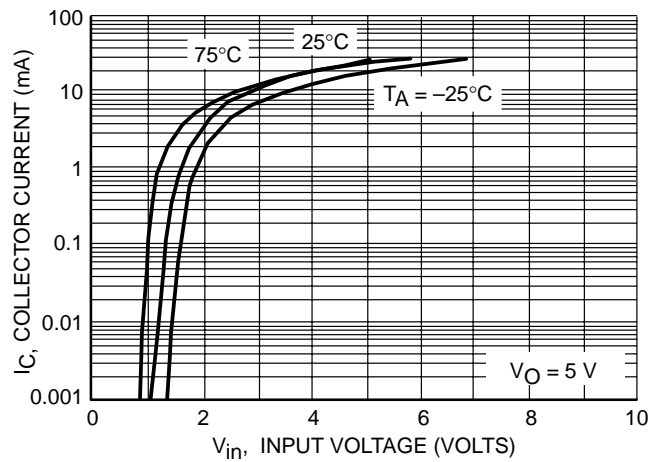

Figure 15. Output Current vs. Input Voltage

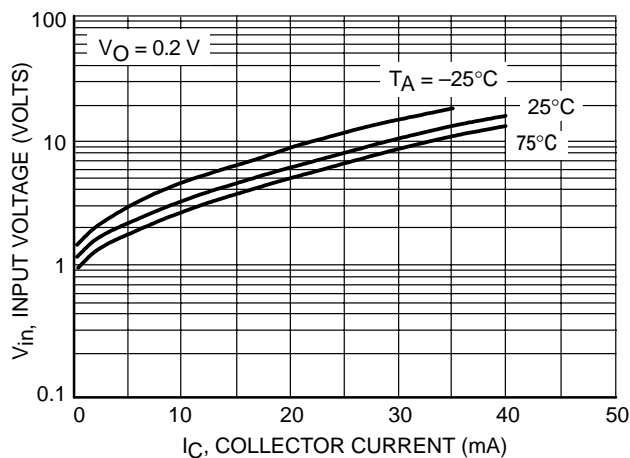

Figure 16. Input Voltage vs. Output Current

LMUN2211LT1G Series

TYPICAL ELECTRICAL CHARACTERISTICS
LMUN2214LT1G

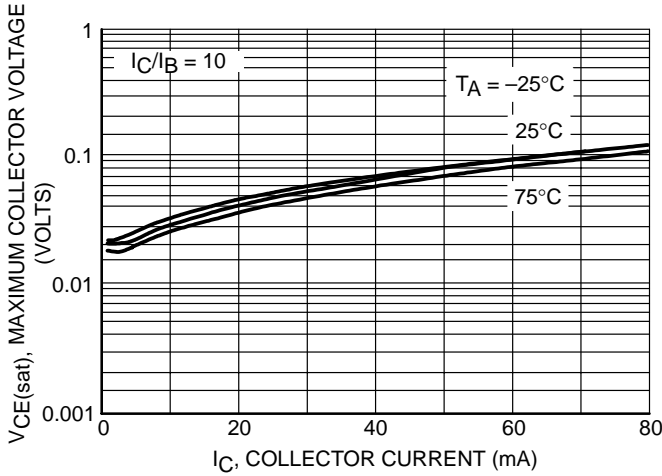

Figure 17. $V_{CE(sat)}$ vs. I_C

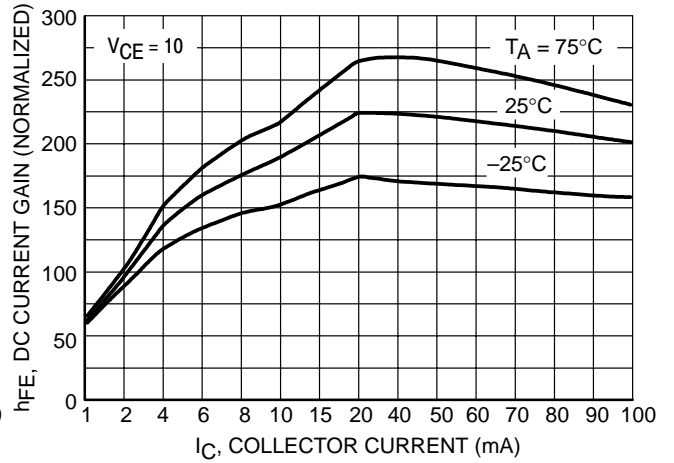

Figure 18. DC Current Gain

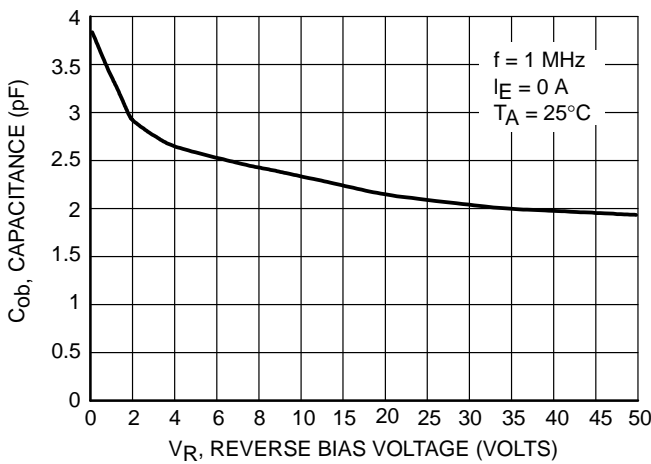

Figure 19. Output Capacitance

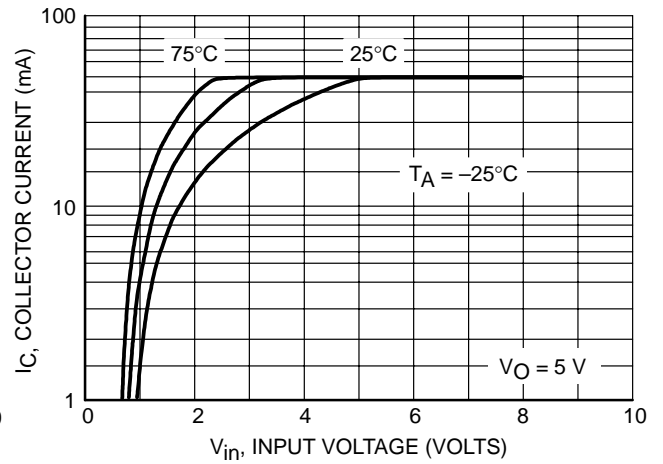

Figure 20. Output Current vs. Input Voltage

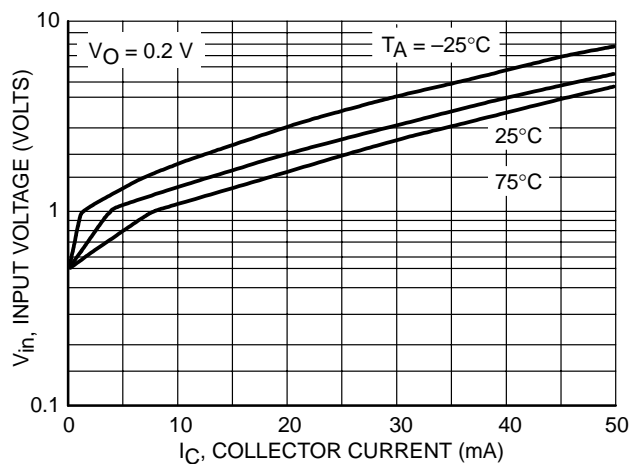

Figure 21. Input Voltage vs. Output Current

LMUN2211LT1G Series

TYPICAL ELECTRICAL CHARACTERISTICS
LMUN2215LT1G

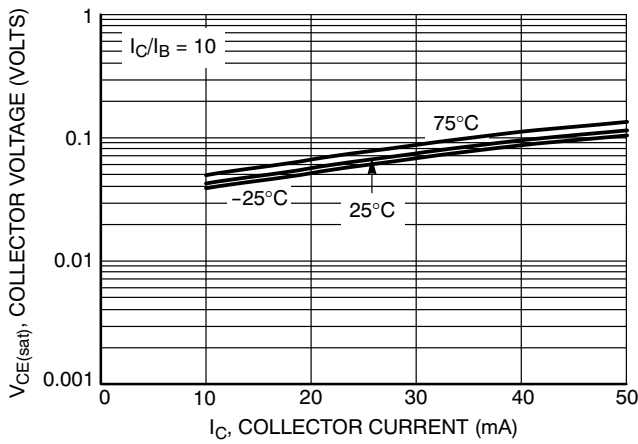

Figure 22. $V_{CE(sat)}$ versus I_C

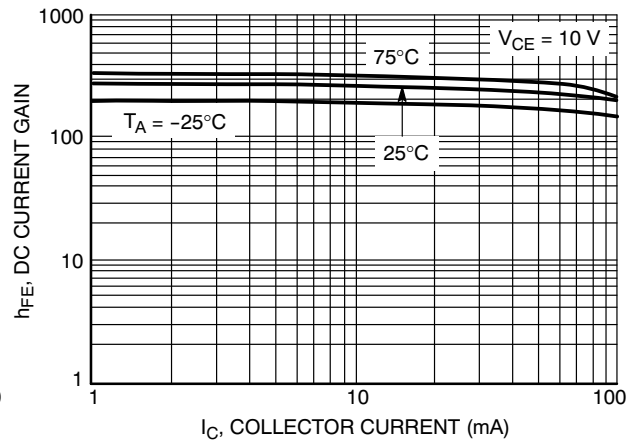

Figure 23. DC Current Gain

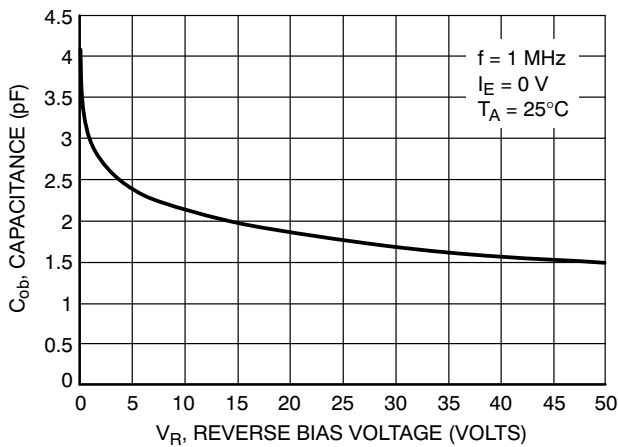

Figure 24. Output Capacitance

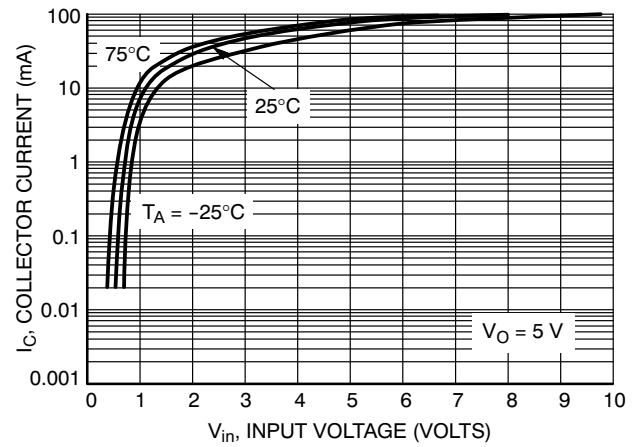

Figure 25. Output Current versus Input Voltage

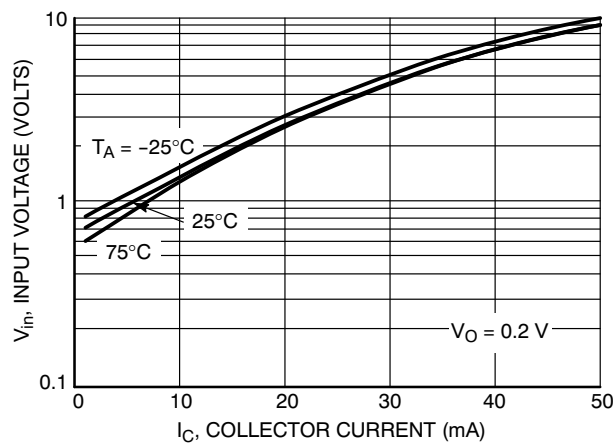

Figure 26. Input Voltage versus Output Current

LMUN2211LT1G Series

TYPICAL ELECTRICAL CHARACTERISTICS
LMUN2216LT1G

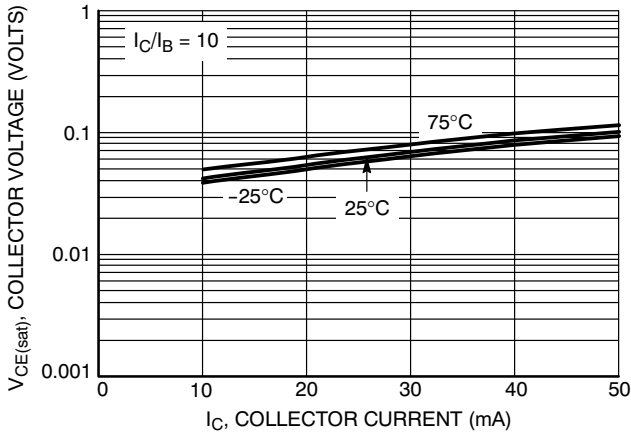

Figure 27. $V_{CE(sat)}$ versus I_C

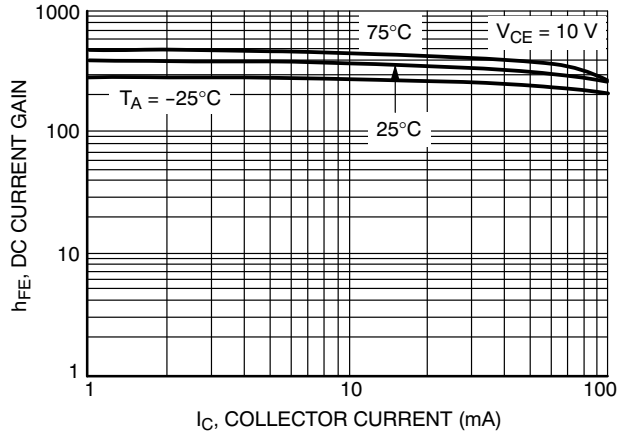

Figure 28. DC Current Gain

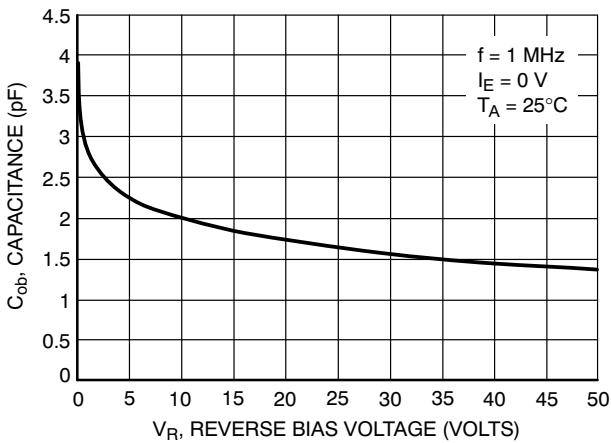

Figure 29. Output Capacitance

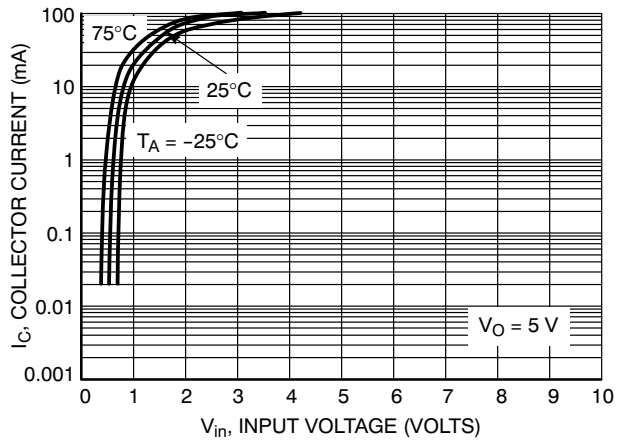

Figure 30. Output Current versus Input Voltage

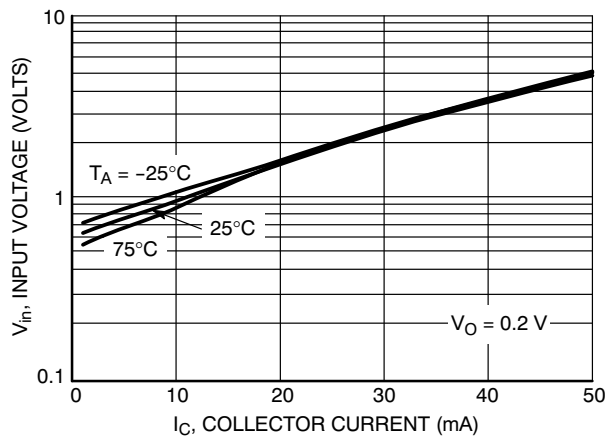

Figure 31. Input Voltage versus Output Current

LMUN2211LT1G Series

TYPICAL ELECTRICAL CHARACTERISTICS
LMUN2230LT1G

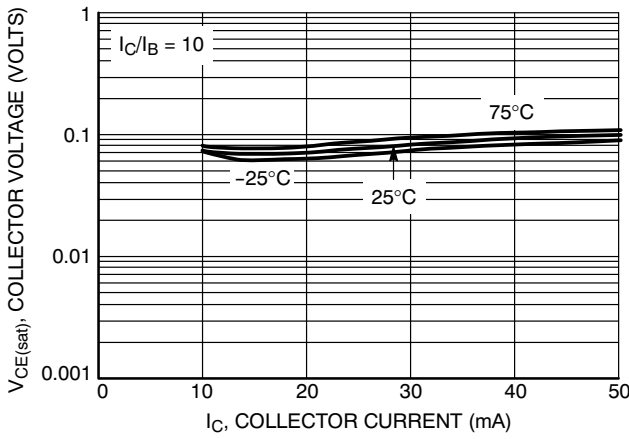

Figure 32. $V_{CE(sat)}$ versus I_C

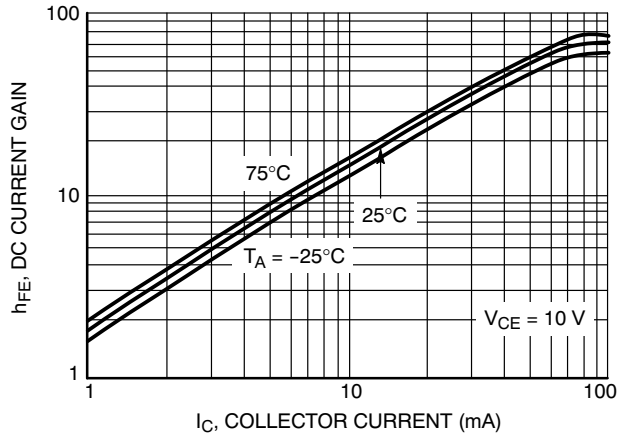

Figure 33. DC Current Gain

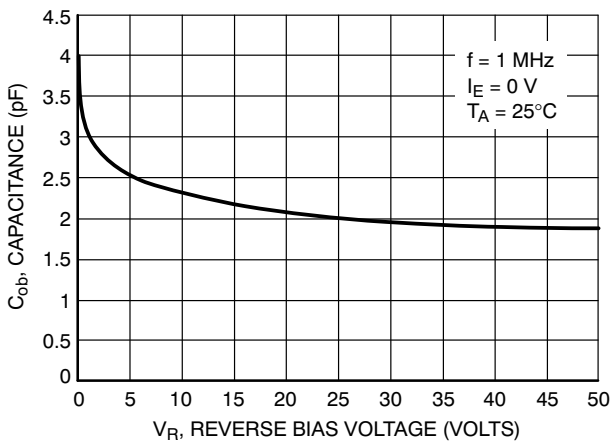

Figure 34. Output Capacitance

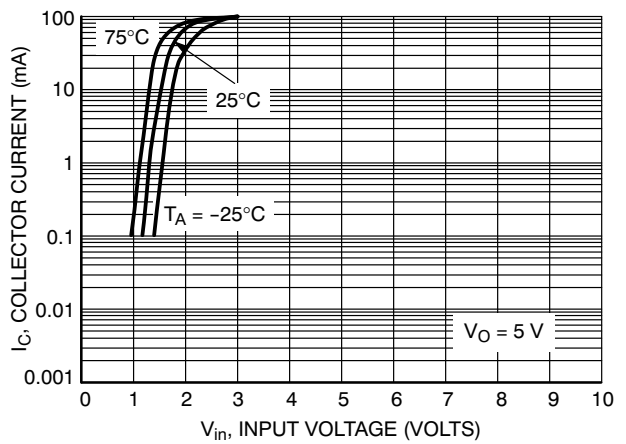

Figure 35. Output Current versus Input Voltage

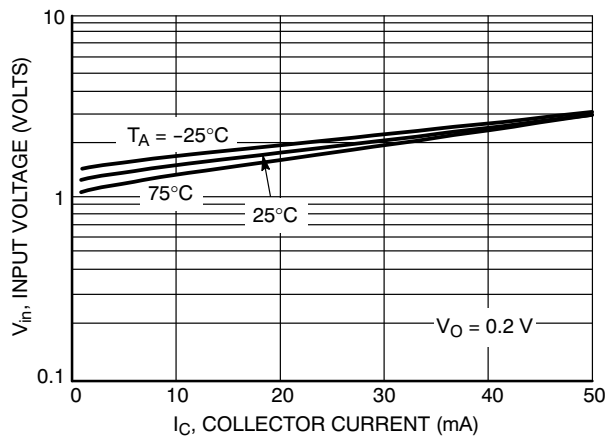

Figure 36. Input Voltage versus Output Current

LMUN2211LT1G Series

TYPICAL ELECTRICAL CHARACTERISTICS
LMUN2231LT1G

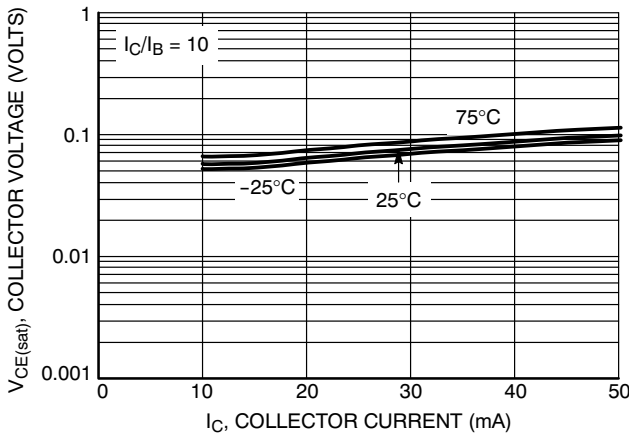

Figure 37. $V_{CE(sat)}$ versus I_C

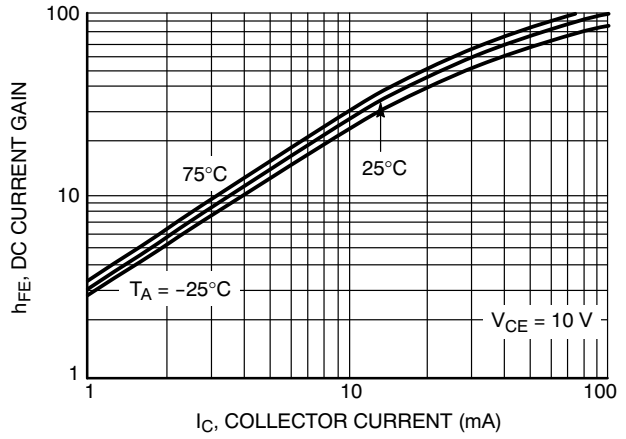

Figure 38. DC Current Gain

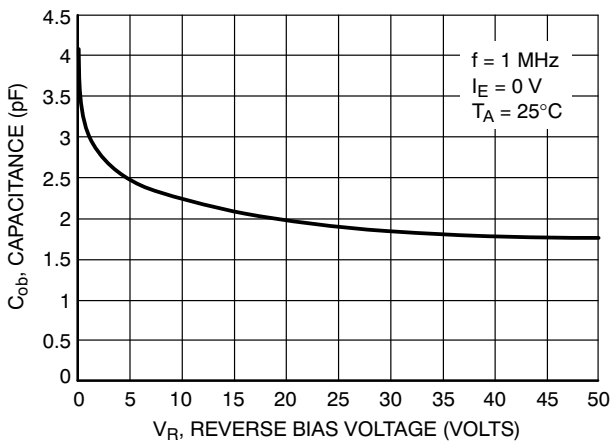

Figure 39. Output Capacitance

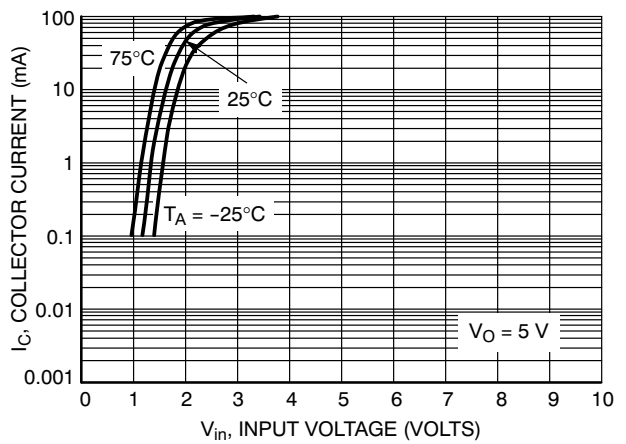

Figure 40. Output Current versus Input Voltage

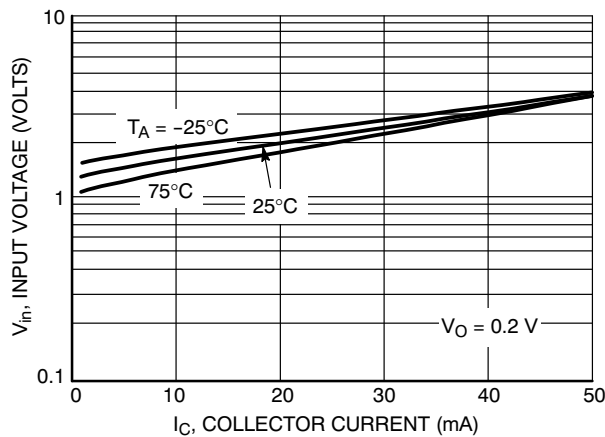

Figure 41. Input Voltage versus Output Current

LMUN2211LT1G Series

TYPICAL ELECTRICAL CHARACTERISTICS
LMUN2232LT1G

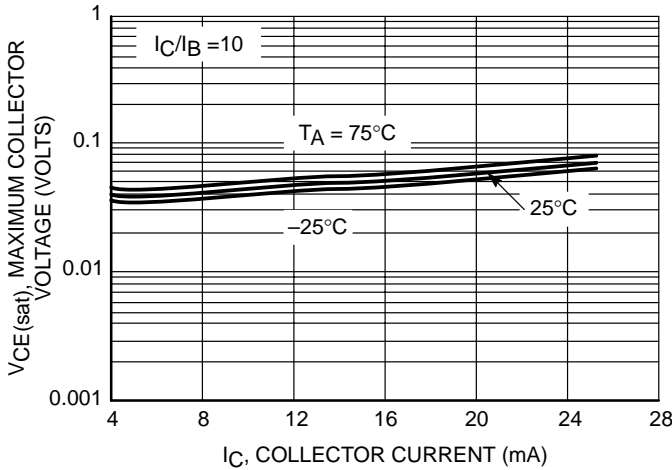

Figure 22. $V_{CE(sat)}$ vs. I_C

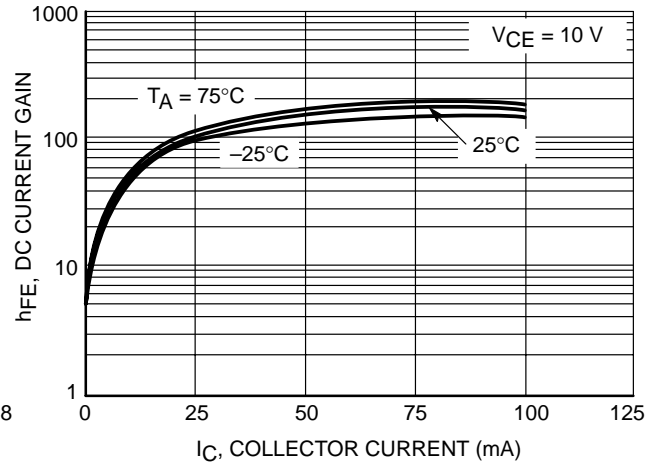

Figure 23. DC Current Gain

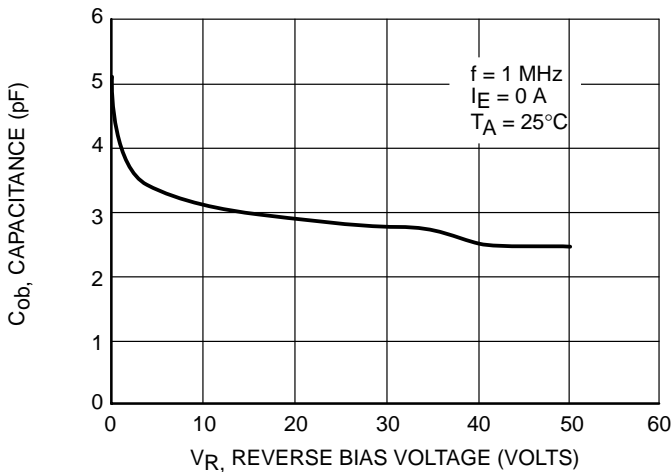

Figure 24. Output Capacitance

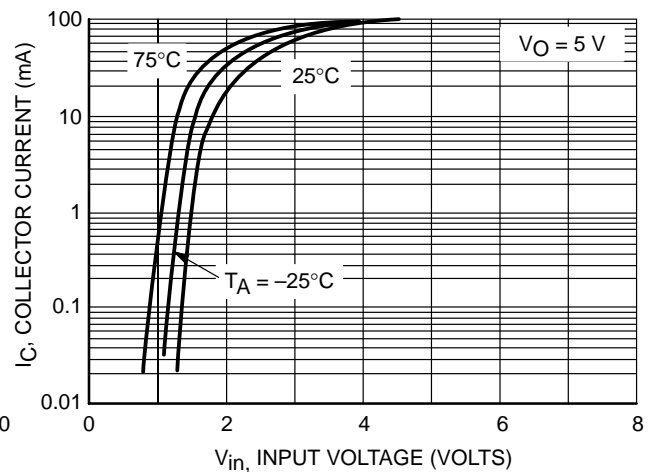

Figure 25. Output Current vs. Input Voltage

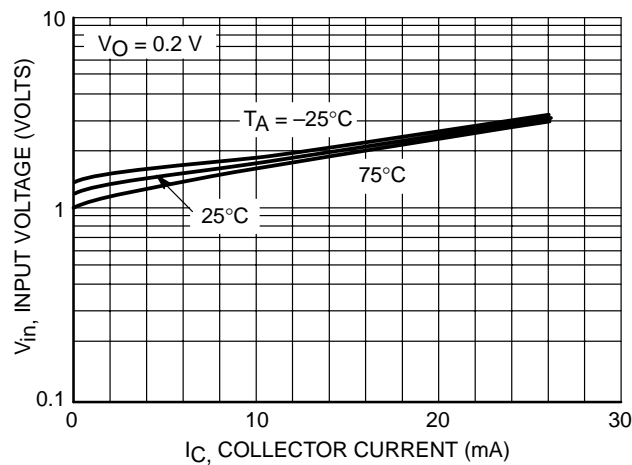

Figure 26. Output Voltage vs. Input Current

LMUN2211LT1G Series

TYPICAL ELECTRICAL CHARACTERISTICS
LMUN2233LT1G

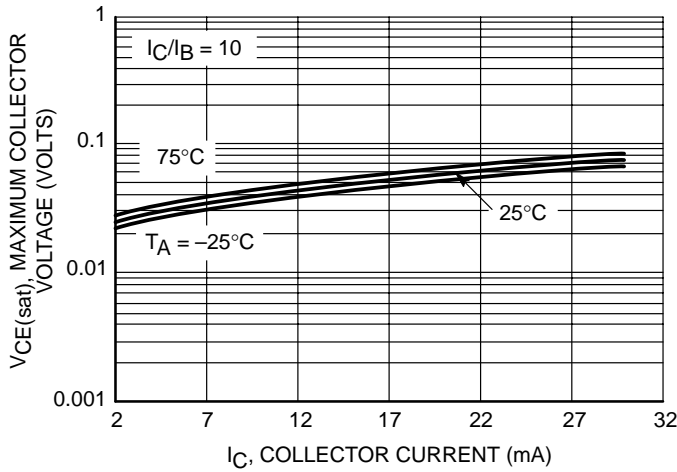

Figure 27. $V_{CE(sat)}$ vs. I_C

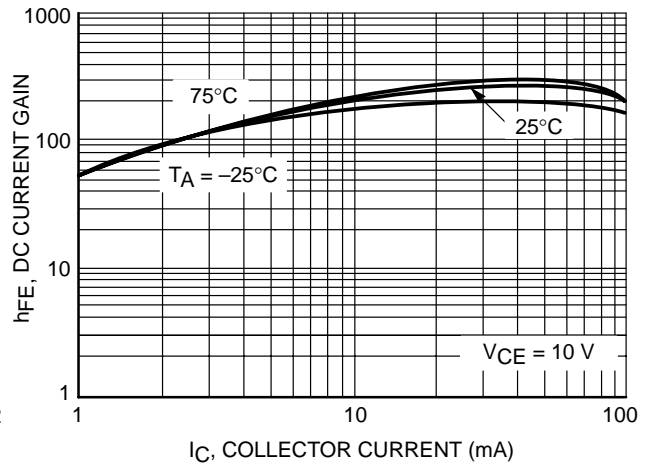

Figure 28. DC Current Gain

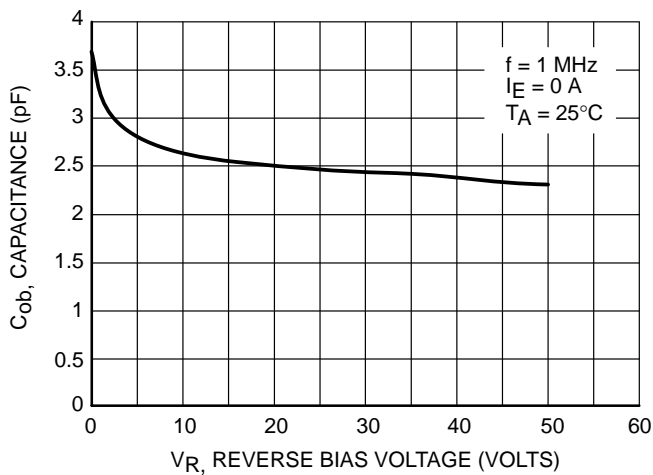

Figure 29. Output Capacitance

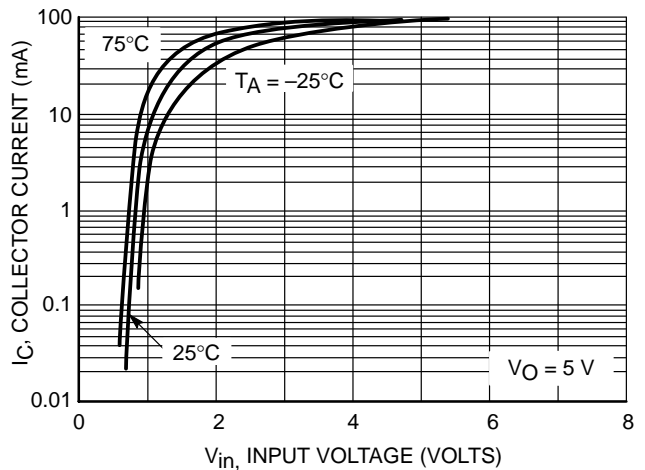

Figure 30. Output Current vs. Input Voltage

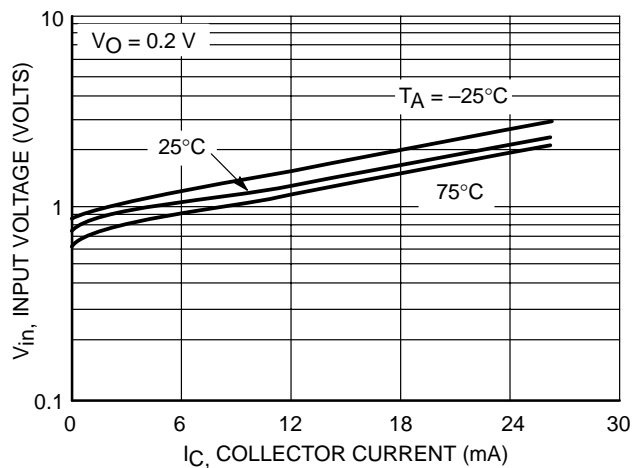

Figure 31. Input Voltage vs. Output Current

LMUN2211LT1G Series

TYPICAL ELECTRICAL CHARACTERISTICS
LMUN2234LT1G

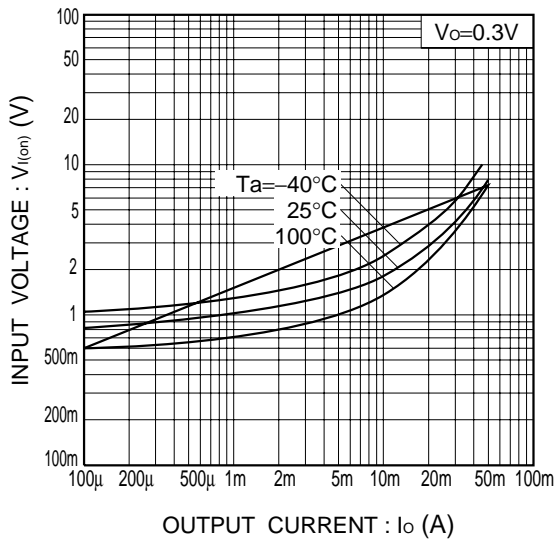

Fig.1 Input voltage vs. output current (ON characteristics)

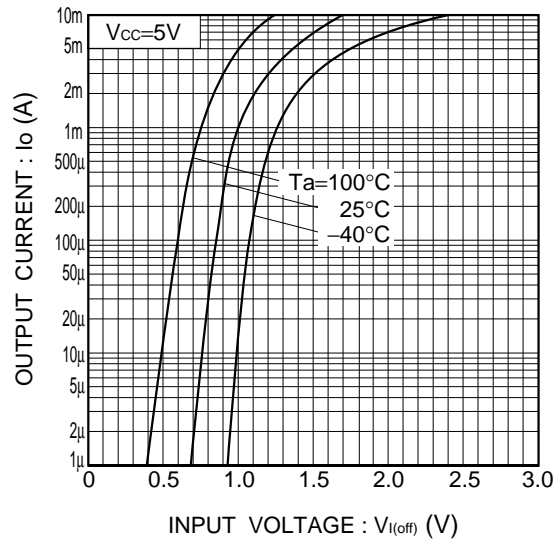

Fig.2 Output current vs. input voltage (OFF characteristics)

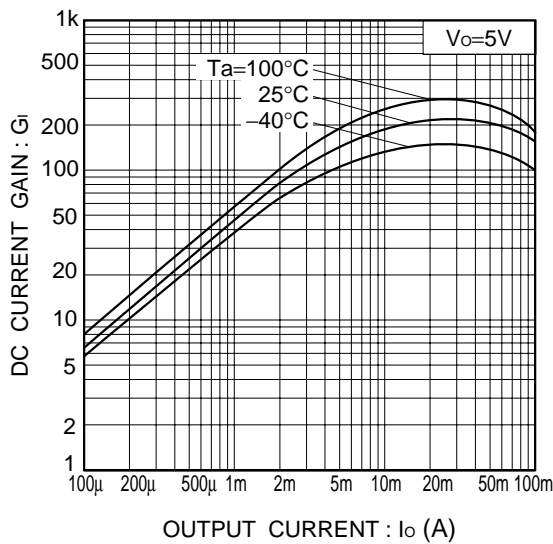

Fig.3 DC current gain vs. output current

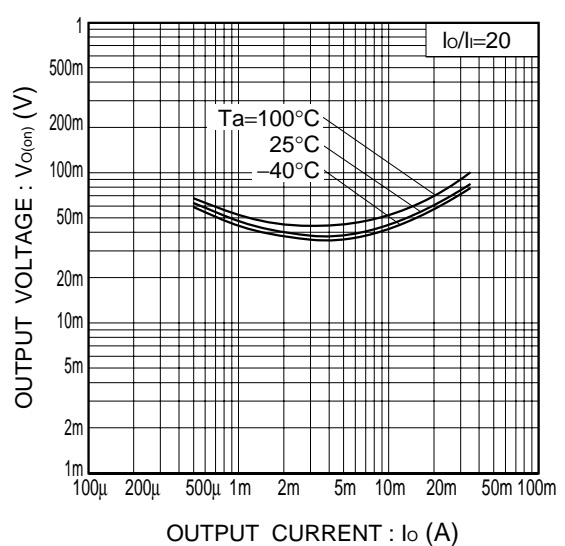

Fig.4 Output voltage vs. output current

LMUN2211LT1G Series

TYPICAL APPLICATIONS FOR NPN BRTs

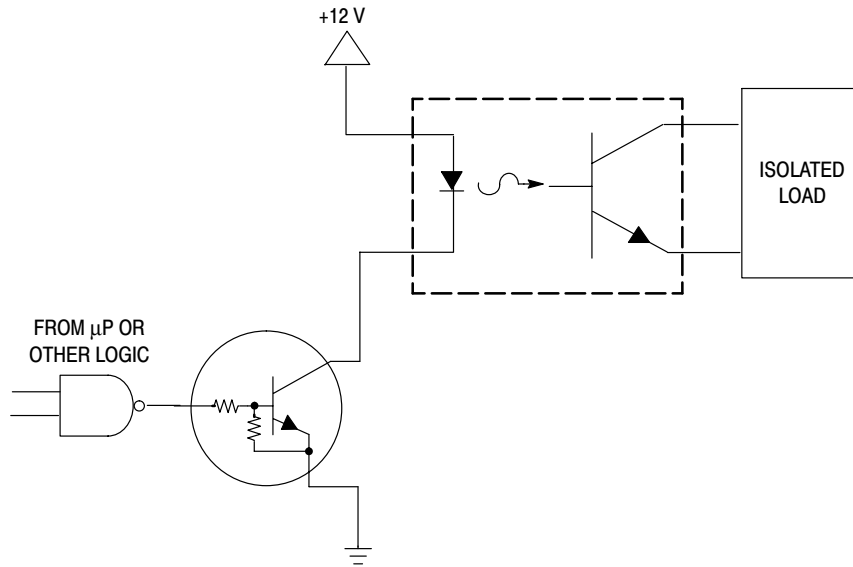

Figure 32. Level Shifter: Connects 12 or 24 Volt Circuits to Logic

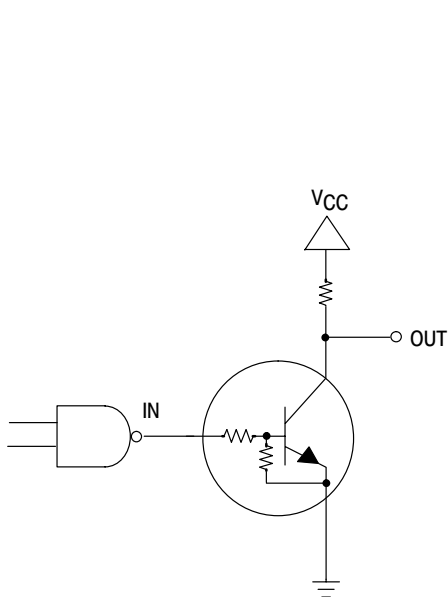

Figure 33. Open Collector Inverter: Inverts the Input Signal

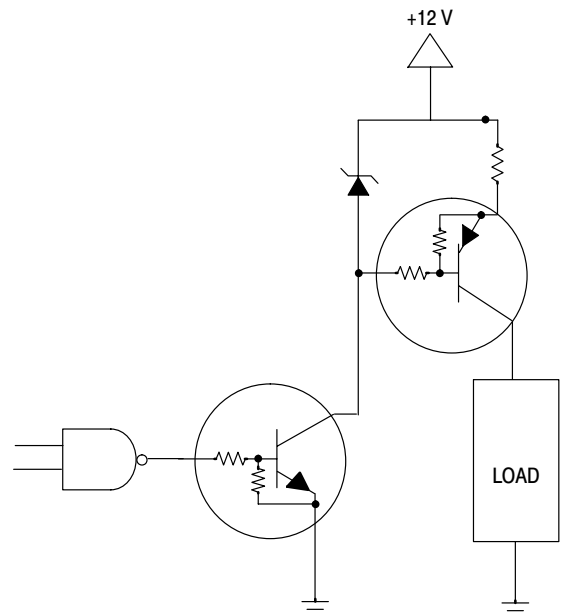
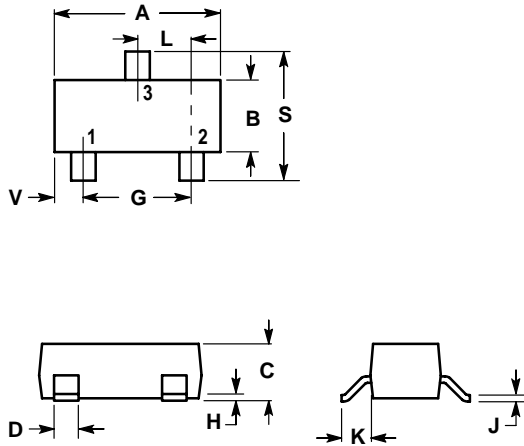

Figure 34. Inexpensive, Unregulated Current Source

LMUN2211LT1G Series

SOT-23



NOTES:

1. DIMENSIONING AND TOLERANCING PER ANSI Y14.5M, 1982.
2. CONTROLLING DIMENSION: INCH.

| DIM | INCHES | | MILLIMETERS | |
|-----|--------|--------|-------------|-------|
| | MIN | MAX | MIN | MAX |
| A | 0.1102 | 0.1197 | 2.80 | 3.04 |
| B | 0.0472 | 0.0551 | 1.20 | 1.40 |
| C | 0.0350 | 0.0440 | 0.89 | 1.11 |
| D | 0.0150 | 0.0200 | 0.37 | 0.50 |
| G | 0.0701 | 0.0807 | 1.78 | 2.04 |
| H | 0.0005 | 0.0040 | 0.013 | 0.100 |
| J | 0.0034 | 0.0070 | 0.085 | 0.177 |
| K | 0.0140 | 0.0285 | 0.35 | 0.69 |
| L | 0.0350 | 0.0401 | 0.89 | 1.02 |
| S | 0.0830 | 0.1039 | 2.10 | 2.64 |
| V | 0.0177 | 0.0236 | 0.45 | 0.60 |

