

Bias Resistor Transistor

NPN Silicon Surface Mount Transistor with Monolithic Bias Resistor Network

This new series of digital transistors is designed to replace a single device and its external resistor bias network. The BRT (Bias Resistor Transistor) contains a single transistor with a monolithic bias network

resistor. The BRT eliminates these individual components by integrating them into a single device. The use of a BRT can reduce both system cost and board space. The device is housed in the SOT-23 package which is designed for low power surface mount applications.

- Simplifies Circuit Design
- Reduces Board Space and Component Count
- The SOT-23 package can be soldered using wave or reflow. The modified gull-winged leads absorb thermal stress during soldering eliminating the possibility of damage to the die.
- Available in 8 mm embossed tape and reel. Use the Device Number to order the 7 inch/3000 unit reel. Replace “T1” with “T3” in the Device Number to order the 13 inch/10,000 unit reel.

LMUN2211LT1G SERIES

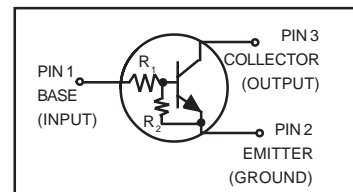

We declare that the material of product compliance with RoHS requirements.

MAXIMUM RATINGS (T_A = 25°C unless otherwise noted)

Rating	Symbol	Value	Unit
Collector-Base Voltage	V _{CBO}	50	Vdc
Collector-Emitter Voltage	V _{CEO}	50	Vdc
Collector Current	I _C	100	mAdc
Total Power Dissipation @ T _A = 25°C (Note 1.) Derate above 25°C	P _D	246 1.5	mW °C/W

DEVICE MARKING AND RESISTOR VALUES

Device	Marking	R1(K)	R2(K)
LMUN2211LT1G	A8A	10	10
LMUN2212LT1G	A8B	22	22
LMUN2213LT1G	A8C	47	47
LMUN2214LT1G	A8D	10	47
LMUN2215LT1G	A8E	10	∞
LMUN2216LT1G	A8F	4.7	∞
LMUN2230LT1G	A8G	1.0	1.0
LMUN2231LT1G	A8H	2.2	2.2
LMUN2232LT1G	A8J	4.7	4.7
LMUN2233LT1G	A8K	4.7	47
LMUN2234LT1G	A8L	22	47
LMUN2235LT1G	A8M	2.2	47
LMUN2238LT1G	A8R	2.2	∞
LMUN2241LT1G	A8U	100	∞

1. Device mounted on a FR-4 glass epoxy printed circuit board using the minimum recommended footprint.

Ordering Information

Device	Package	Shipping
LMUN22XXLT1G	SOT23	3000/Tape&Reel
LMUN22XXLT3G	SOT23	10000/Tape&Reel

ORDERING INFORMATION

Device	Package	Shipping
LMUN2211LT1G	SOT-23	3000/Tape & Reel
LMUN2212LT1G	SOT-23	3000/Tape & Reel
LMUN2213LT1G	SOT-23	3000/Tape & Reel
LMUN2214LT1G	SOT-23	3000/Tape & Reel
LMUN2215LT1G	SOT-23	3000/Tape & Reel
LMUN2216LT1G	SOT-23	3000/Tape & Reel
LMUN2230LT1G	SOT-23	3000/Tape & Reel
LMUN2231LT1G	SOT-23	3000/Tape & Reel
LMUN2232LT1G	SOT-23	3000/Tape & Reel
LMUN2233LT1G	SOT-23	3000/Tape & Reel
LMUN2234LT1G	SOT-23	3000/Tape & Reel
LMUN2235LT1G	SOT-23	3000/Tape & Reel
LMUN2238LT1G	SOT-23	3000/Tape & Reel
LMUN2241LT1G	SOT-23	3000/Tape & Reel

LMUN2211LT1G Series

THERMAL CHARACTERISTICS

Rating	Symbol	Value	Unit
Thermal Resistance – Junction-to-Ambient (Note 1.)	$R_{\theta JA}$	508	°C/W
Operating and Storage Temperature Range	T_J, T_{stg}	-55 to +150	°C
Maximum Temperature for Soldering Purposes, Time in Solder Bath	T_L	260 10	°C Sec

ELECTRICAL CHARACTERISTICS ($T_A = 25^\circ\text{C}$ unless otherwise noted)

Characteristic	Symbol	Min	Typ	Max	Unit
----------------	--------	-----	-----	-----	------

OFF CHARACTERISTICS

Collector-Base Cutoff Current ($V_{CB} = 50\text{ V}, I_E = 0$)	I_{CBO}	–	–	100	nAdc
Collector-Emitter Cutoff Current ($V_{CE} = 50\text{ V}, I_B = 0$)	I_{CEO}	–	–	500	nAdc
Emitter-Base Cutoff Current ($V_{EB} = 6.0\text{ V}, I_C = 0$)	I_{EBO}	–	–	0.5	mAdc
LMUN2211LT1G		–	–	0.2	
LMUN2212LT1G		–	–	0.1	
LMUN2213LT1G		–	–	0.2	
LMUN2214LT1G		–	–	0.9	
LMUN2215LT1G		–	–	1.9	
LMUN2216LT1G		–	–	4.3	
LMUN2230LT1G		–	–	2.3	
LMUN2231LT1G		–	–	1.5	
LMUN2232LT1G		–	–	0.18	
LMUN2233LT1G		–	–	0.13	
LMUN2234LT1G		–	–	0.2	
LMUN2235LT1G		–	–	4.0	
LMUN2238LT1G		–	–	0.1	
LMUN2241LT1G		–	–		
Collector-Base Breakdown Voltage ($I_C = 10\ \mu\text{A}, I_E = 0$)	$V_{(BR)CBO}$	50	–	–	Vdc
Collector-Emitter Breakdown Voltage (Note 2.), ($I_C = 2.0\text{ mA}, I_B = 0$)	$V_{(BR)CEO}$	50	–	–	Vdc

ON CHARACTERISTICS (Note 2.)

DC Current Gain ($V_{CE} = 10\text{ V}, I_C = 5.0\text{ mA}$)	h_{FE}	35	60	–	
LMUN2211LT1G		60	100	–	
LMUN2212LT1G		80	140	–	
LMUN2213LT1G		80	140	–	
LMUN2214LT1G		160	350	–	
LMUN2215LT1G		160	350	–	
LMUN2216LT1G		3.0	5.0	–	
LMUN2230LT1G		8.0	15	–	
LMUN2231LT1G		15	30	–	
LMUN2232LT1G		80	200	–	
LMUN2233LT1G		80	150	–	
LMUN2234LT1G		80	140	–	
LMUN2235LT1G		160	350	–	
LMUN2238LT1G		160	350	–	
LMUN2241LT1G				–	
Collector-Emitter Saturation Voltage ($I_C = 10\text{ mA}, I_B = 0.3\text{ mA}$) ($I_C = 10\text{ mA}, I_B = 5\text{ mA}$) LMUN2230LT1G/LMUN2231LT1G ($I_C = 10\text{ mA}, I_B = 1\text{ mA}$) LMUN2215LT1G/LMUN2216LT1G LMUN2232LT1G/LMUN2233LT1G/LMUN2234LT1G/ LMUN2235LT1G/LMUN2238LT1G	$V_{CE(sat)}$	–	–	0.25	Vdc

2. Pulse Test: Pulse Width < 300 μs , Duty Cycle < 2.0%.

LMUN2211LT1G Series

ELECTRICAL CHARACTERISTICS ($T_A = 25^\circ\text{C}$ unless otherwise noted) (Continued)

Characteristic	Symbol	Min	Typ	Max	Unit
ON CHARACTERISTICS (Note 3.)					
Output Voltage (on) ($V_{CC} = 5.0\text{ V}$, $V_B = 2.5\text{ V}$, $R_L = 1.0\text{ k}\Omega$)	V_{OL}	–	–	0.2	Vdc
LMUN2211LT1G		–	–	0.2	
LMUN2212LT1G		–	–	0.2	
LMUN2214LT1G		–	–	0.2	
LMUN2215LT1G		–	–	0.2	
LMUN2216LT1G		–	–	0.2	
LMUN2230LT1G		–	–	0.2	
LMUN2231LT1G		–	–	0.2	
LMUN2232LT1G		–	–	0.2	
LMUN2233LT1G		–	–	0.2	
LMUN2234LT1G		–	–	0.2	
LMUN2235LT1G		–	–	0.2	
LMUN2238LT1G		–	–	0.2	
($V_{CC} = 5.0\text{ V}$, $V_B = 3.5\text{ V}$, $R_L = 1.0\text{ k}\Omega$)		–	–	0.2	
($V_{CC} = 5.0\text{ V}$, $V_B = 5.0\text{ V}$, $R_L = 1.0\text{ k}\Omega$)		–	–	0.2	
LMUN2213LT1G		–	–	0.2	
LMUN2241LT1G		–	–	0.2	
Output Voltage (off) ($V_{CC} = 5.0\text{ V}$, $V_B = 0.5\text{ V}$, $R_L = 1.0\text{ k}\Omega$) ($V_{CC} = 5.0\text{ V}$, $V_B = 0.050\text{ V}$, $R_L = 1.0\text{ k}\Omega$) ($V_{CC} = 5.0\text{ V}$, $V_B = 0.25\text{ V}$, $R_L = 1.0\text{ k}\Omega$)	V_{OH}	4.9	–	–	Vdc
LMUN2230LT1G					
LMUN2215LT1G					
LMUN2216LT1G					
LMUN2233LT1G					
LMUN2238LT1G					
Input Resistor	R_1	7.0	10	13	$\text{k}\Omega$
LMUN2211LT1G		15.4	22	28.6	
LMUN2212LT1G		32.9	47	61.1	
LMUN2213LT1G		7.0	10	13	
LMUN2214LT1G		7.0	10	13	
LMUN2215LT1G		3.3	4.7	6.1	
LMUN2216LT1G		0.7	1.0	1.3	
LMUN2230LT1G		1.5	2.2	2.9	
LMUN2231LT1G		3.3	4.7	6.1	
LMUN2232LT1G		3.3	4.7	6.1	
LMUN2233LT1G		15.4	22	28.6	
LMUN2234LT1G		1.54	2.2	2.86	
LMUN2235LT1G		1.54	2.2	2.88	
LMUN2238LT1G		70	100	130	
LMUN2241LT1G					
Resistor Ratio	R_1/R_2	0.8	1.0	1.2	
LMUN2211LT1G/LMUN2212LT1G/LMUN2213LT1G		0.17	0.21	0.25	
LMUN2214LT1G		–	–	–	
LMUN2215LT1G/LMUN2216LT1G/LMUN2238LT1G		–	–	–	
LMUN2241LT1G		–	–	–	
LMUN2230LT1G/LMUN2231LT1G/LMUN2232LT1G		0.8	1.0	1.2	
LMUN2233LT1G		0.055	0.1	0.185	
LMUN2234LT1G		0.38	0.47	0.56	
LMUN2235LT1G		0.038	0.047	0.056	

3. Pulse Test: Pulse Width < 300 μs , Duty Cycle < 2.0%.

LMUN2211LT1G Series

TYPICAL ELECTRICAL CHARACTERISTICS
LMUN2211LT1G

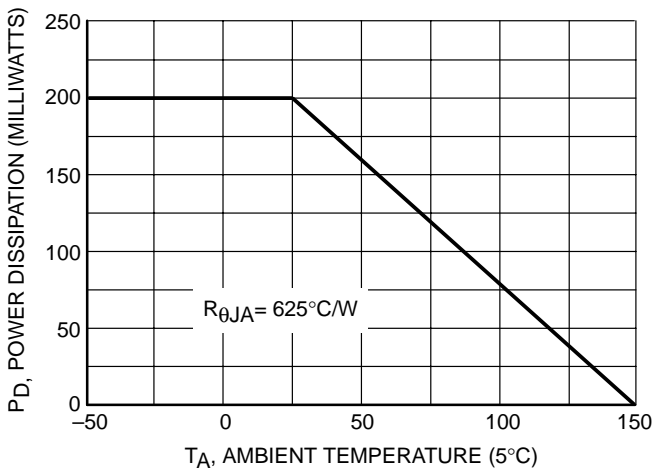

Figure 1. Derating Curve

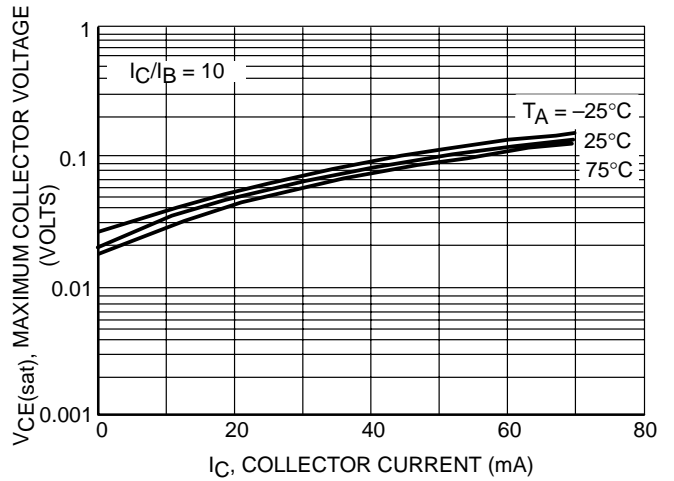

Figure 2. $V_{CE(sat)}$ vs. I_C

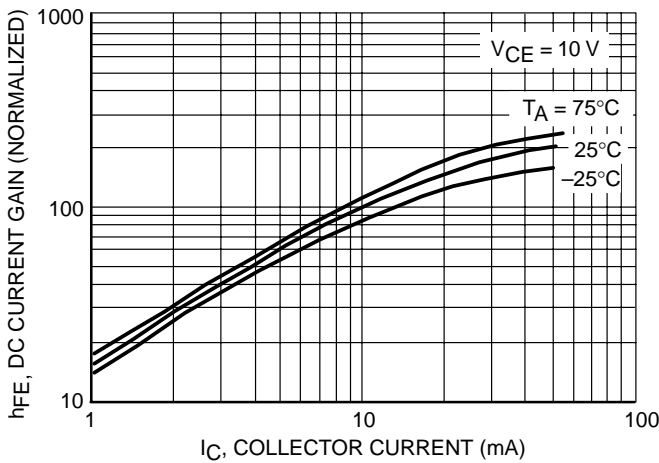

Figure 3. DC Current Gain

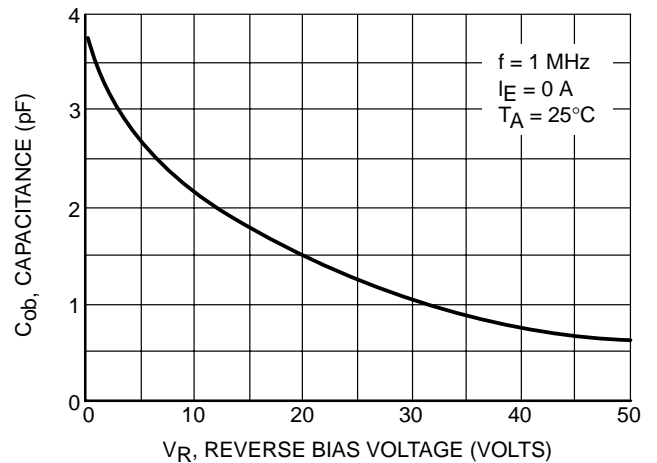

Figure 4. Output Capacitance

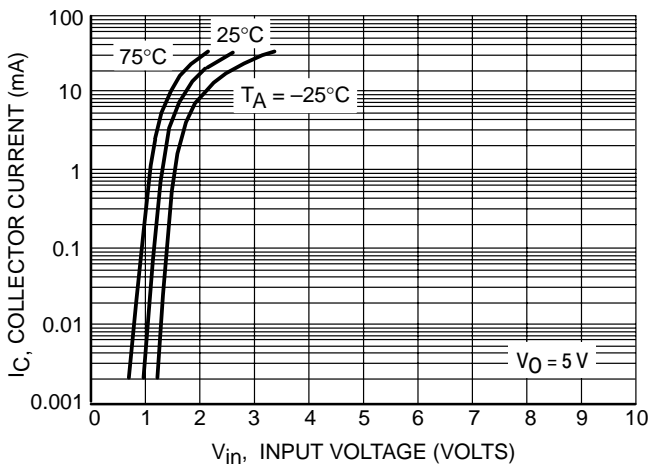

Figure 5. Output Current vs. Input Voltage

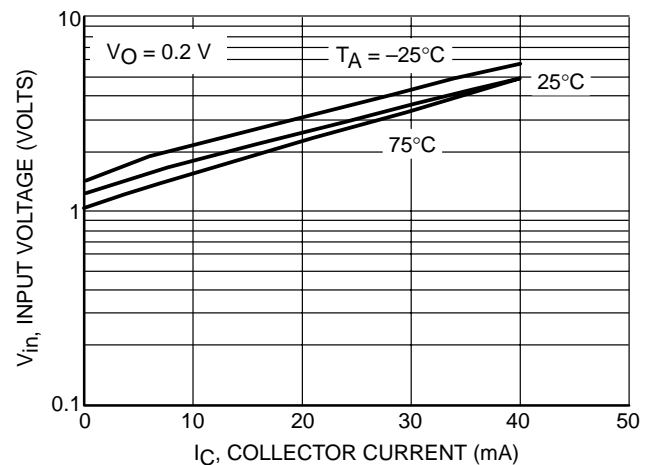

Figure 6. Input Voltage vs. Output Current

LMUN2211LT1G Series

TYPICAL ELECTRICAL CHARACTERISTICS
LMUN2212LT1G

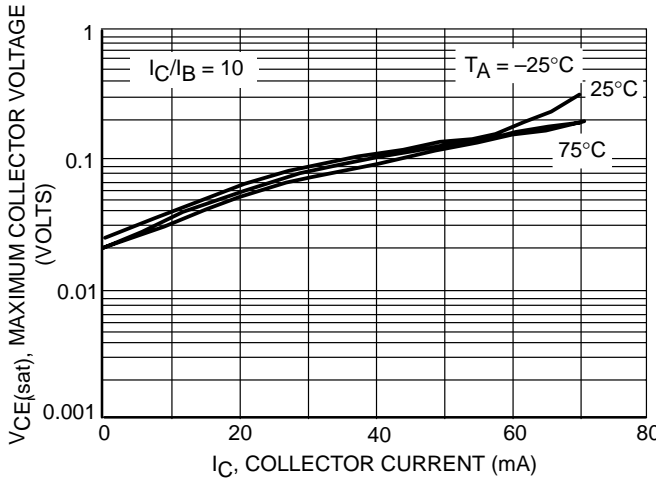

Figure 7. $V_{CE(sat)}$ vs. I_C

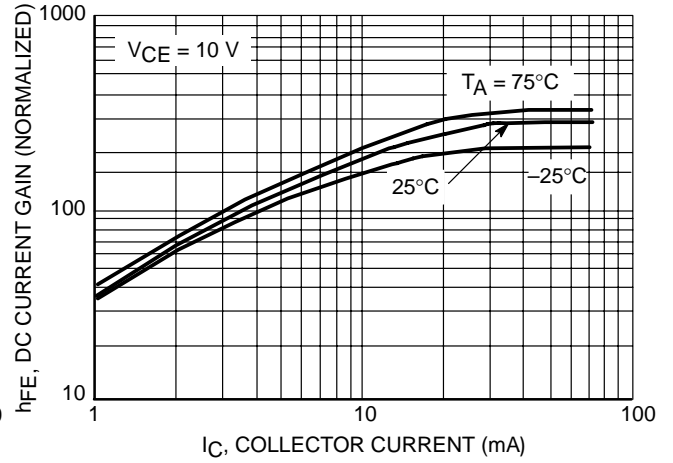

Figure 8. DC Current Gain

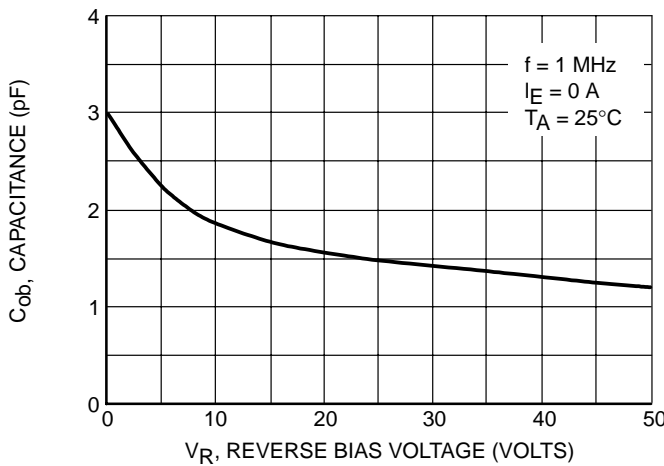

Figure 9. Output Capacitance

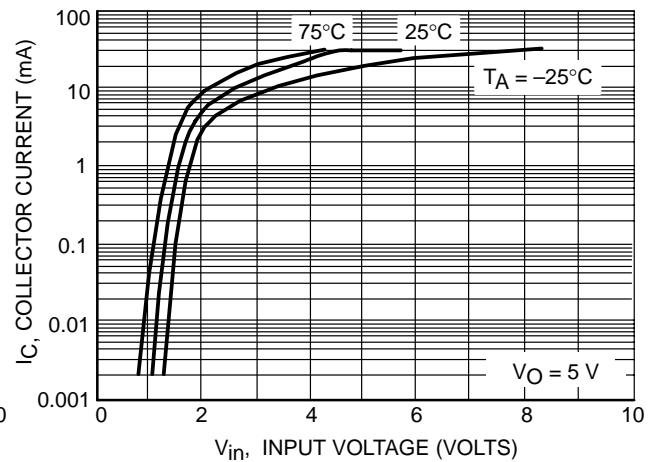

Figure 10. Output Current vs. Input Voltage

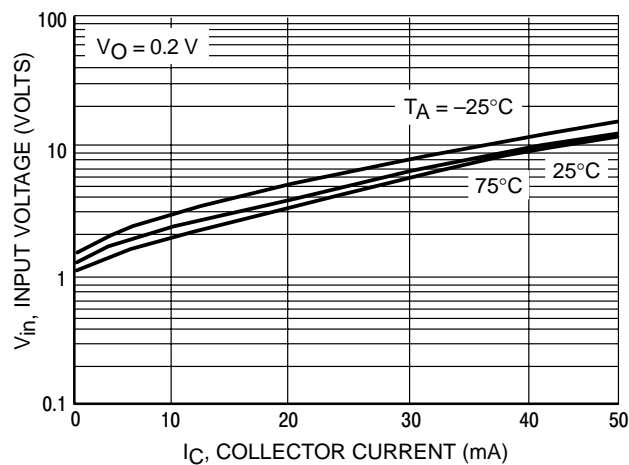

Figure 11. Input Voltage vs. Output Current

LMUN2211LT1G Series

TYPICAL ELECTRICAL CHARACTERISTICS
LMUN2213LT1G

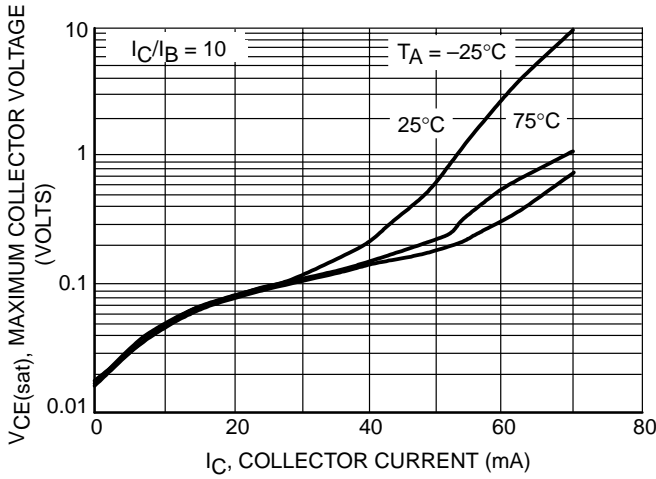

Figure 12. $V_{CE(sat)}$ vs. I_C

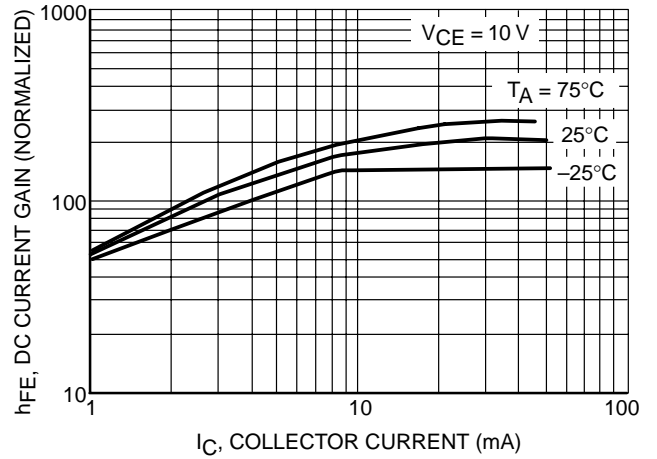

Figure 13. DC Current Gain

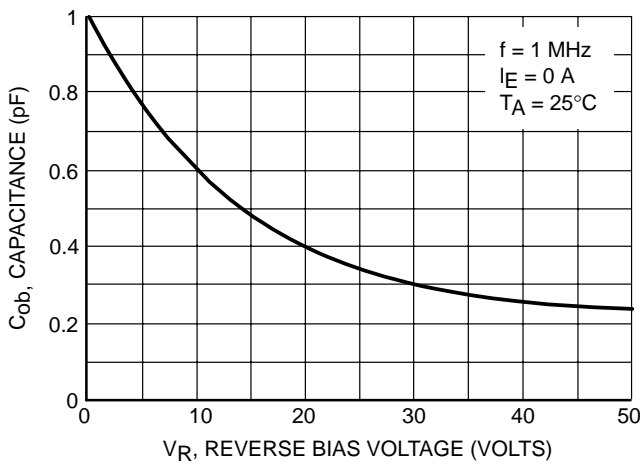

Figure 14. Output Capacitance

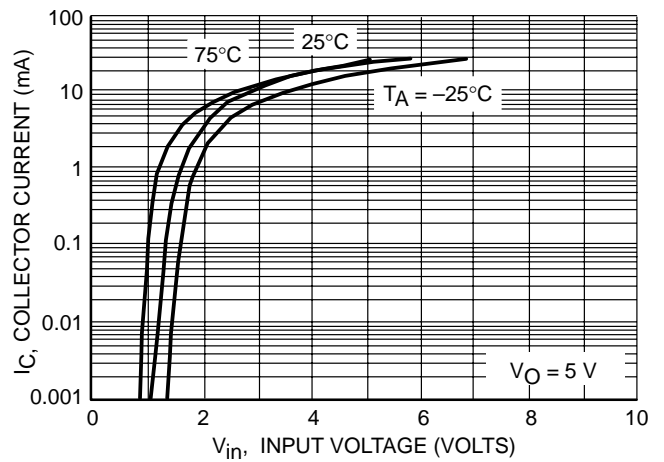

Figure 15. Output Current vs. Input Voltage

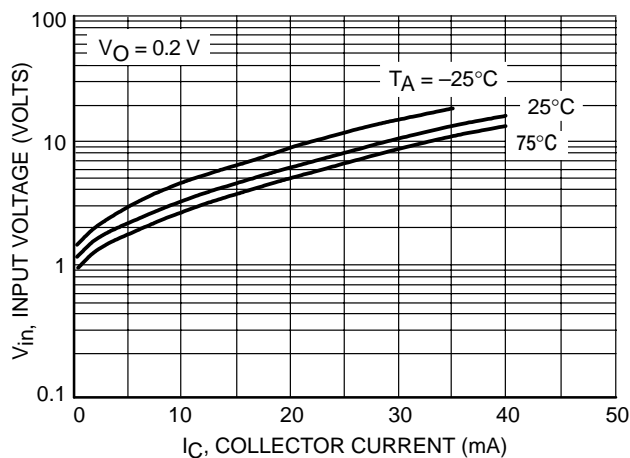

Figure 16. Input Voltage vs. Output Current

LMUN2211LT1G Series

TYPICAL ELECTRICAL CHARACTERISTICS
LMUN2214LT1G

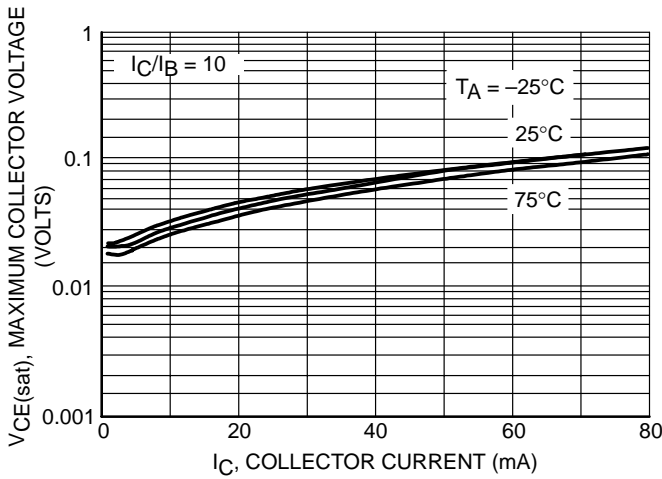

Figure 17. $V_{CE(sat)}$ vs. I_C

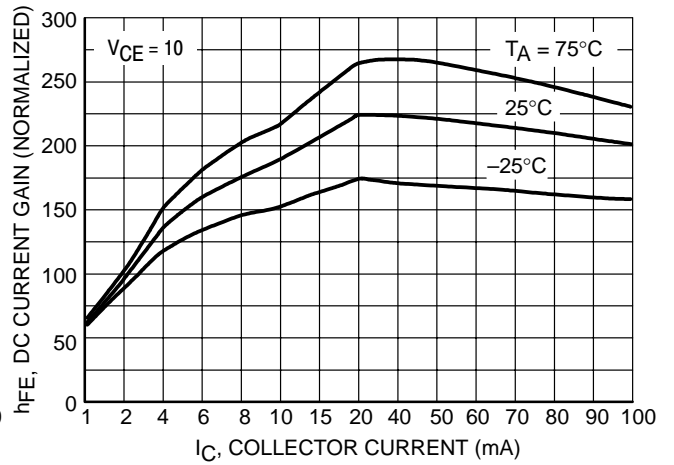

Figure 18. DC Current Gain

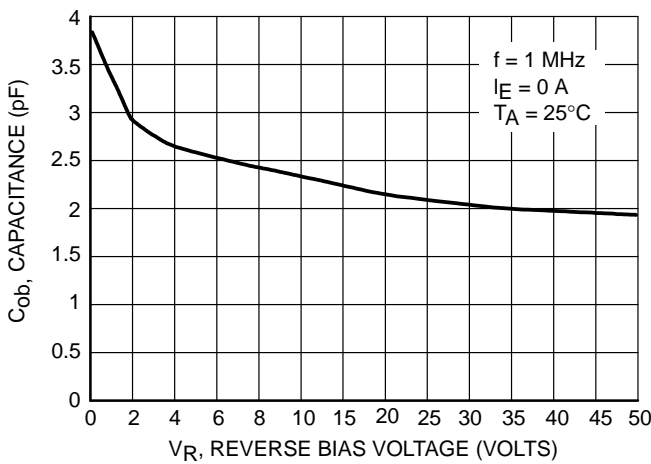

Figure 19. Output Capacitance

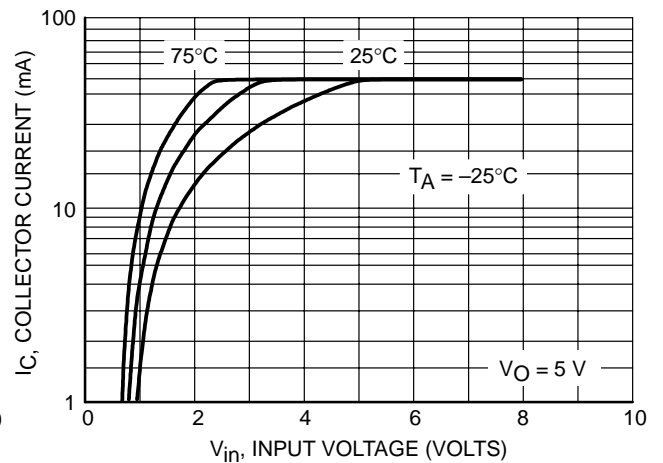

Figure 20. Output Current vs. Input Voltage

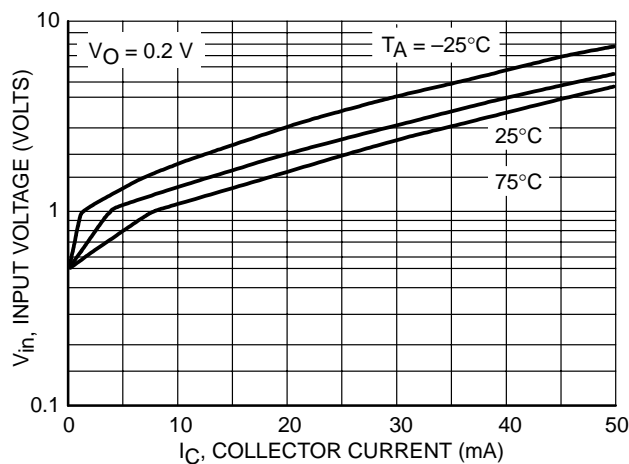

Figure 21. Input Voltage vs. Output Current

LMUN2211LT1G Series

TYPICAL ELECTRICAL CHARACTERISTICS
LMUN2215LT1G

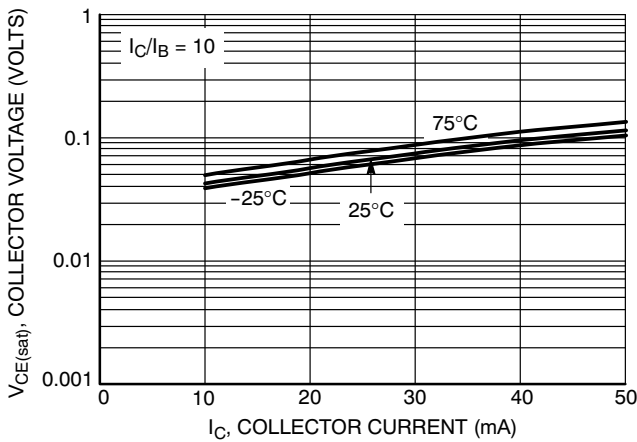

Figure 22. $V_{CE(sat)}$ versus I_C

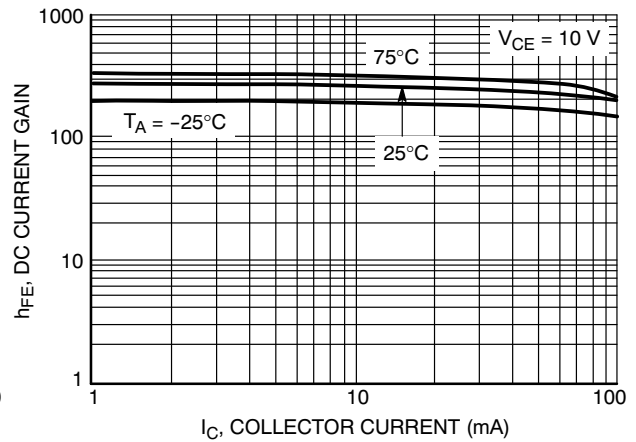

Figure 23. DC Current Gain

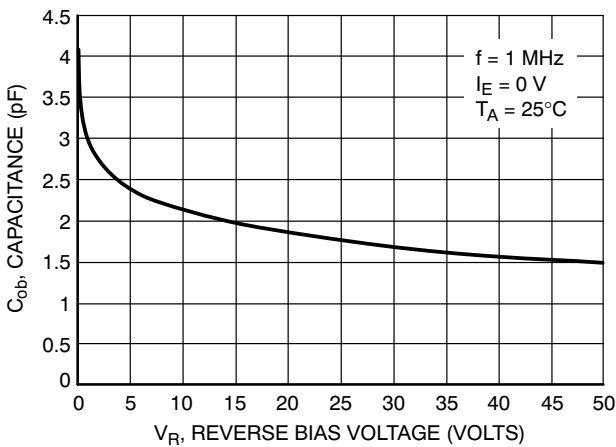

Figure 24. Output Capacitance

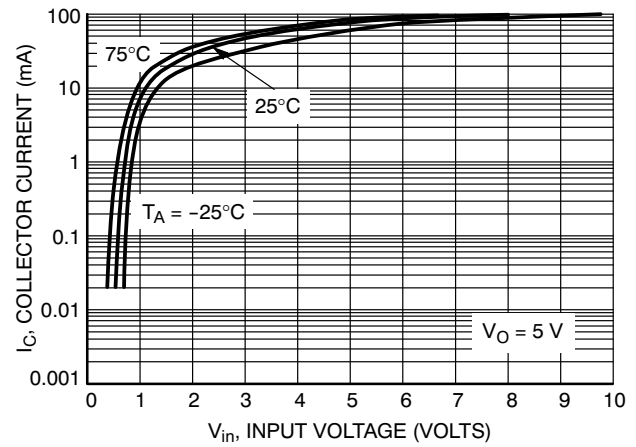

Figure 25. Output Current versus Input Voltage

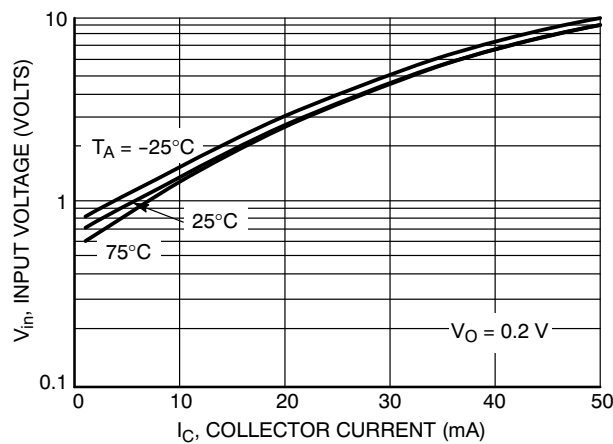

Figure 26. Input Voltage versus Output Current

LMUN2211LT1G Series

TYPICAL ELECTRICAL CHARACTERISTICS
LMUN2216LT1G

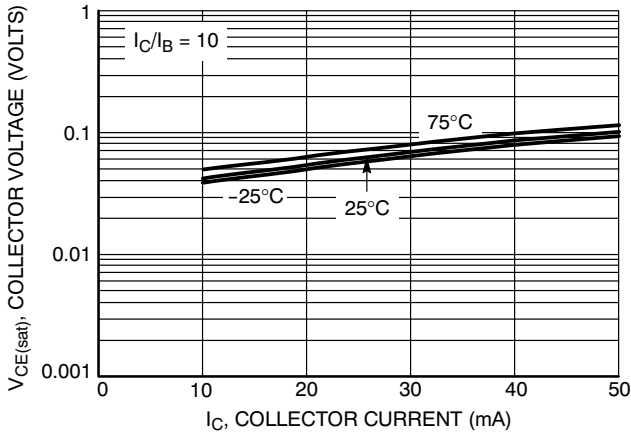

Figure 27. $V_{CE(sat)}$ versus I_C

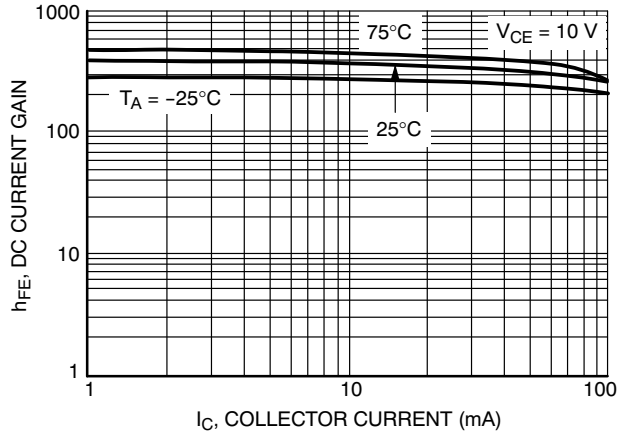

Figure 28. DC Current Gain

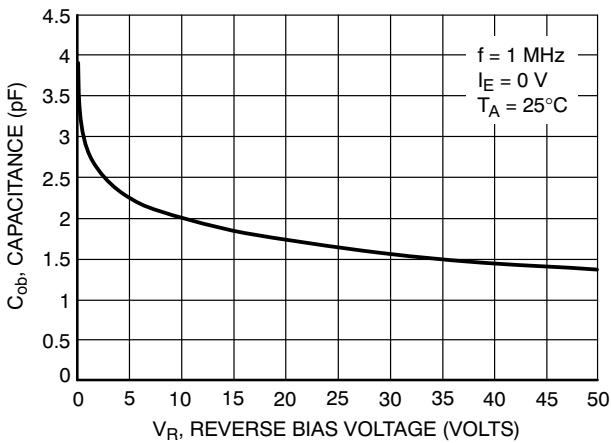

Figure 29. Output Capacitance

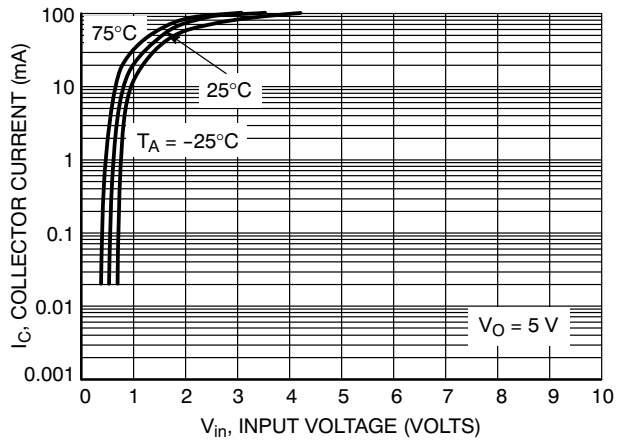

Figure 30. Output Current versus Input Voltage

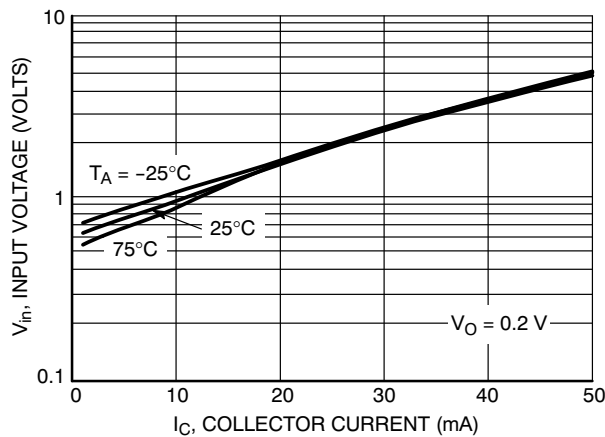

Figure 31. Input Voltage versus Output Current

LMUN2211LT1G Series

TYPICAL ELECTRICAL CHARACTERISTICS
LMUN2230LT1G

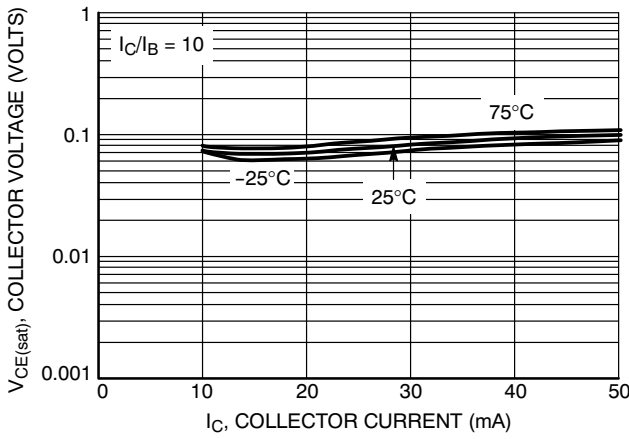

Figure 32. $V_{CE(sat)}$ versus I_C

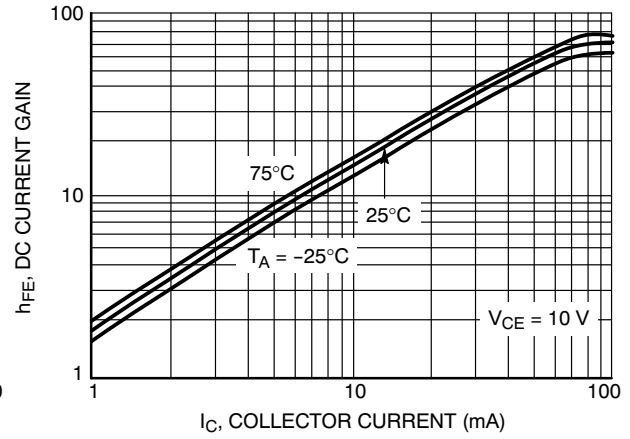

Figure 33. DC Current Gain

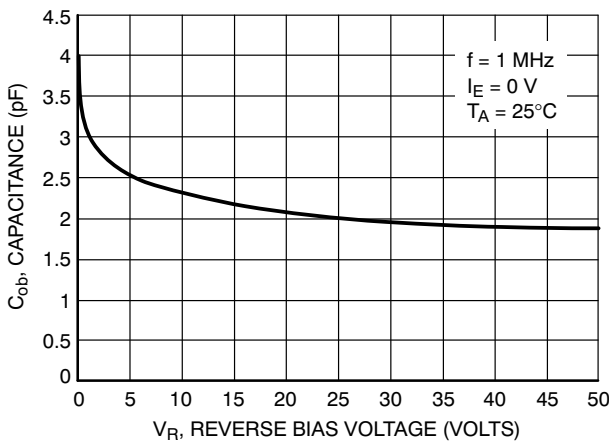

Figure 34. Output Capacitance

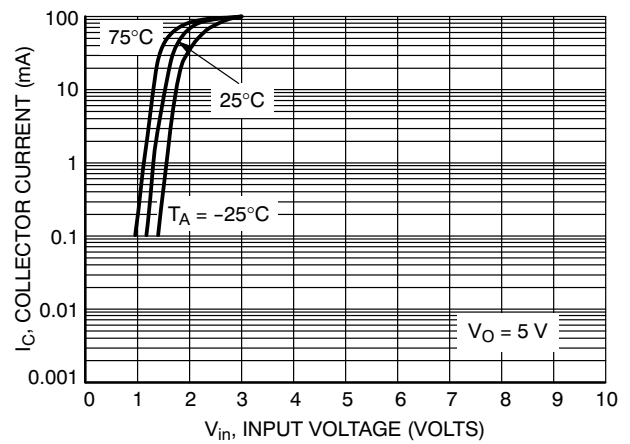

Figure 35. Output Current versus Input Voltage

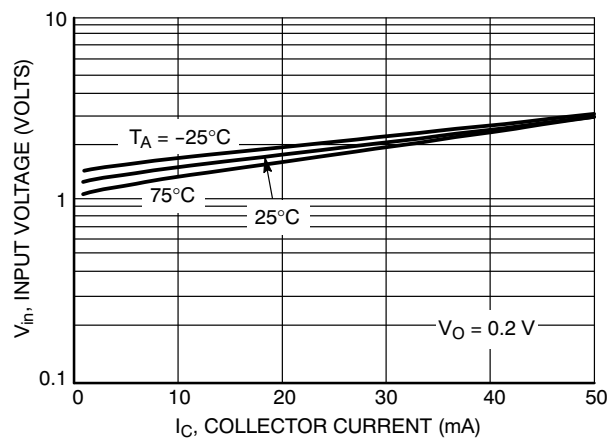

Figure 36. Input Voltage versus Output Current

LMUN2211LT1G Series

TYPICAL ELECTRICAL CHARACTERISTICS
LMUN2231LT1G

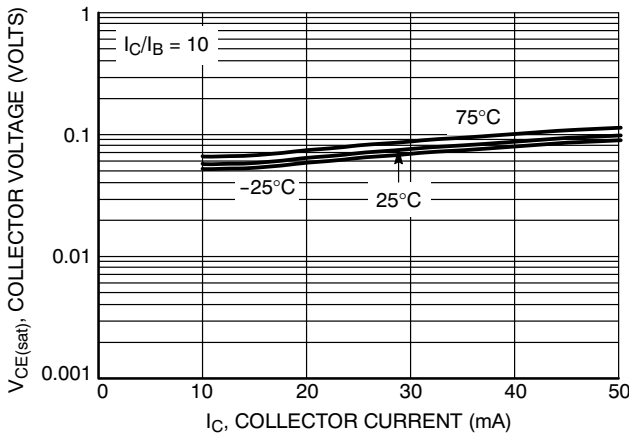

Figure 37. $V_{CE(sat)}$ versus I_C

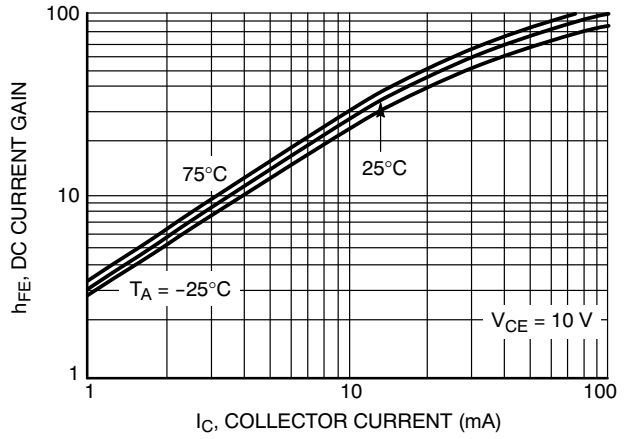

Figure 38. DC Current Gain

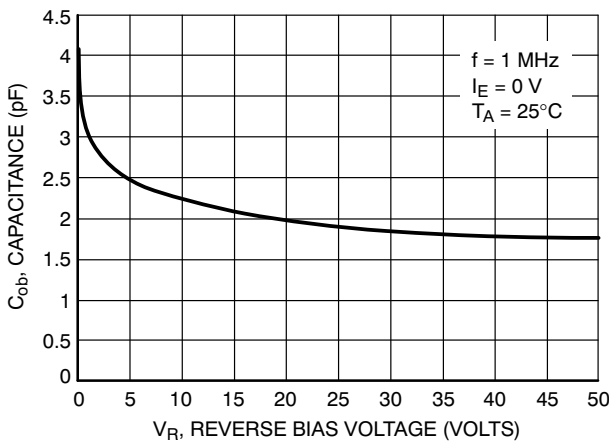

Figure 39. Output Capacitance

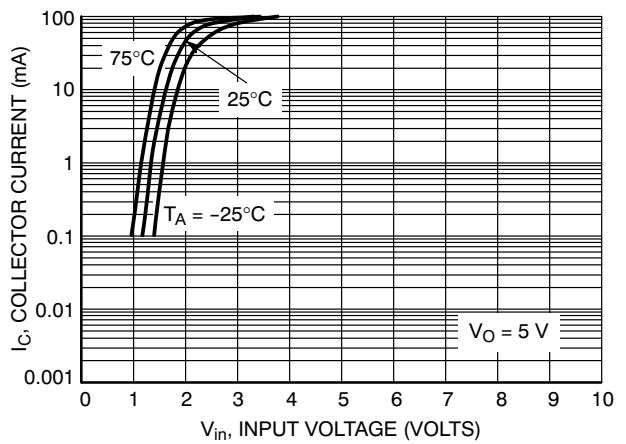

Figure 40. Output Current versus Input Voltage

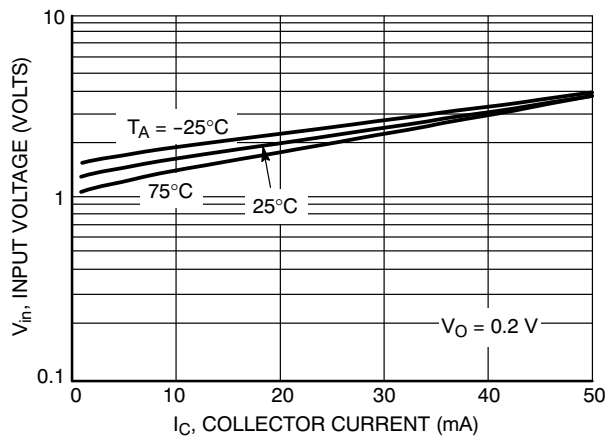

Figure 41. Input Voltage versus Output Current

LMUN2211LT1G Series

TYPICAL ELECTRICAL CHARACTERISTICS
LMUN2232LT1G

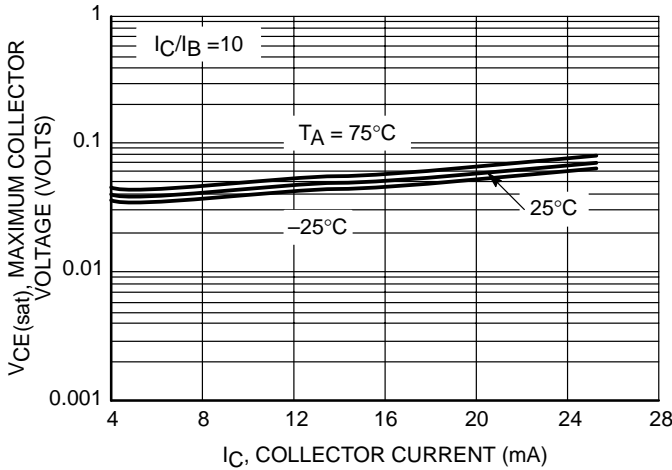

Figure 22. $V_{CE(sat)}$ vs. I_C

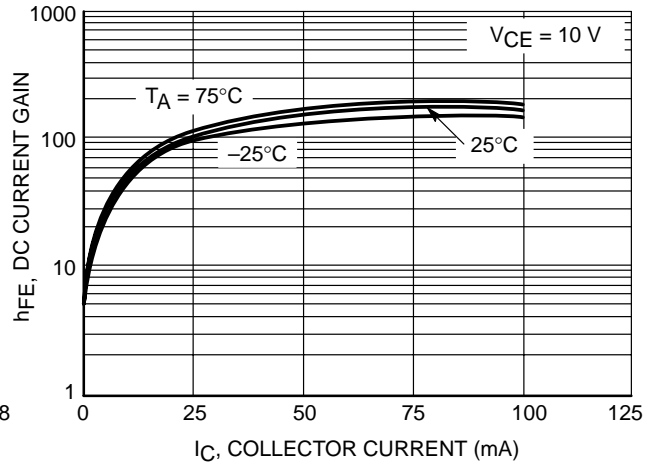

Figure 23. DC Current Gain

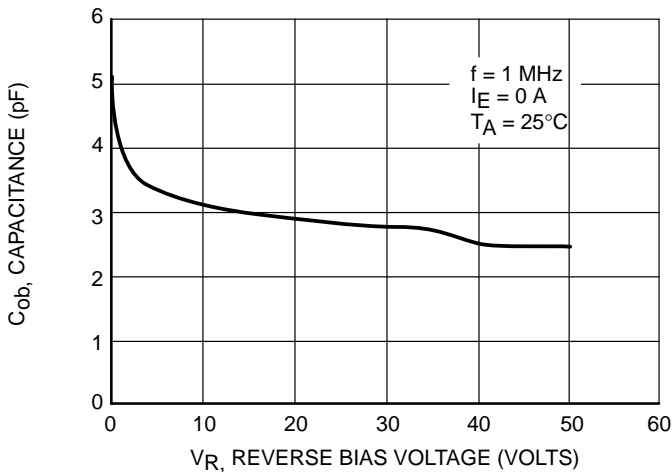

Figure 24. Output Capacitance

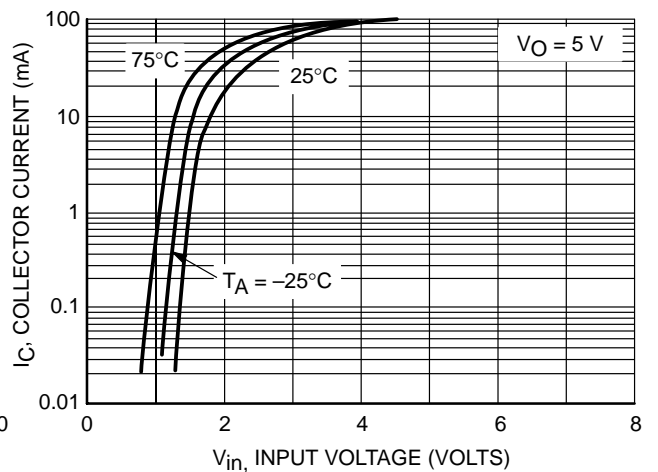

Figure 25. Output Current vs. Input Voltage

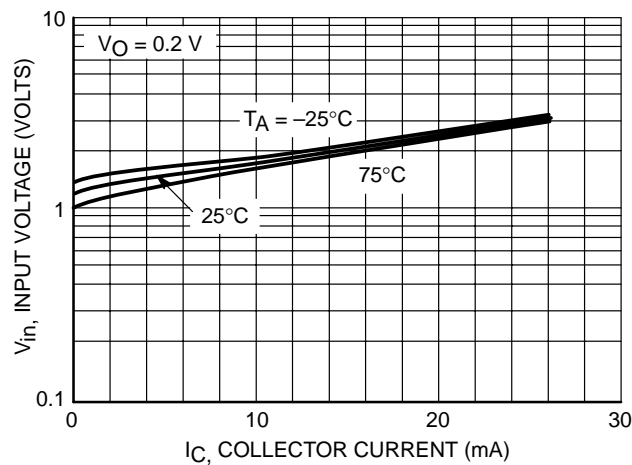

Figure 26. Output Voltage vs. Input Current

LMUN2211LT1G Series

TYPICAL ELECTRICAL CHARACTERISTICS
LMUN2233LT1G

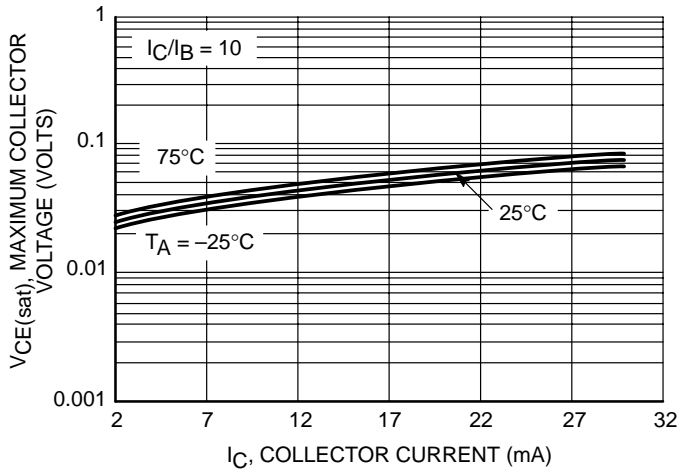

Figure 27. $V_{CE(sat)}$ vs. I_C

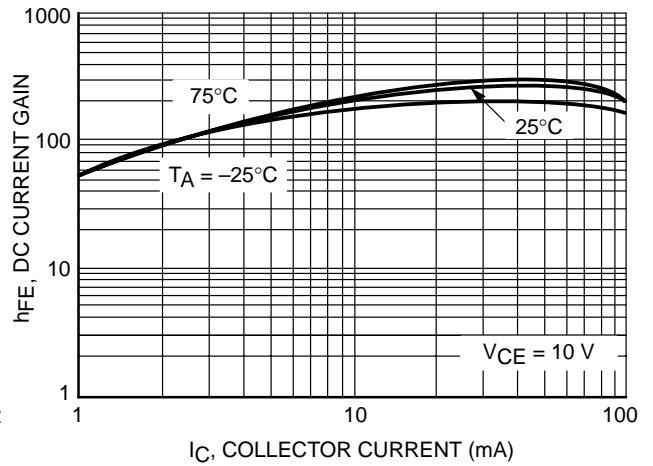

Figure 28. DC Current Gain

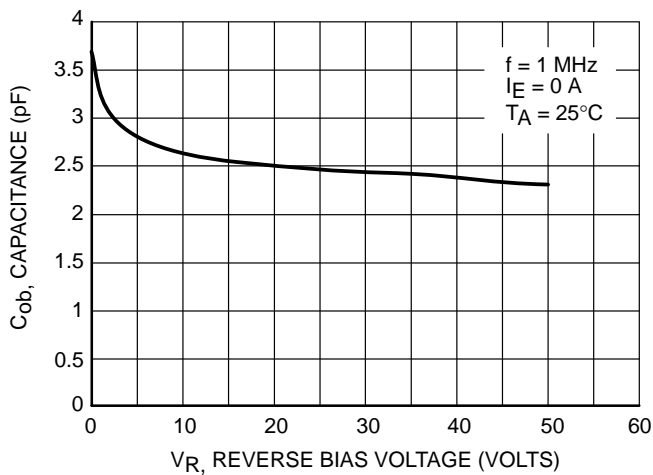

Figure 29. Output Capacitance

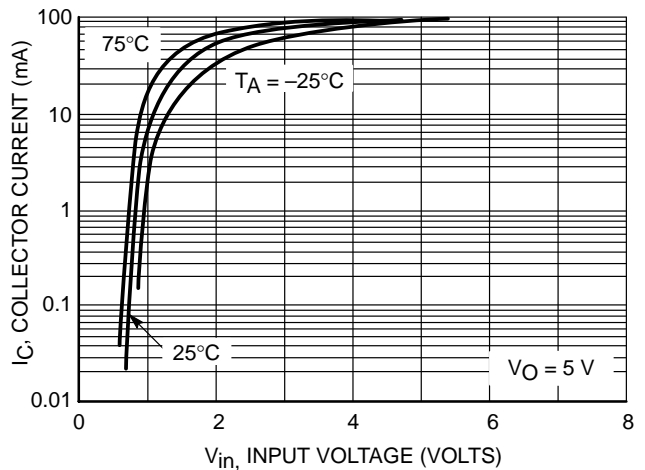

Figure 30. Output Current vs. Input Voltage

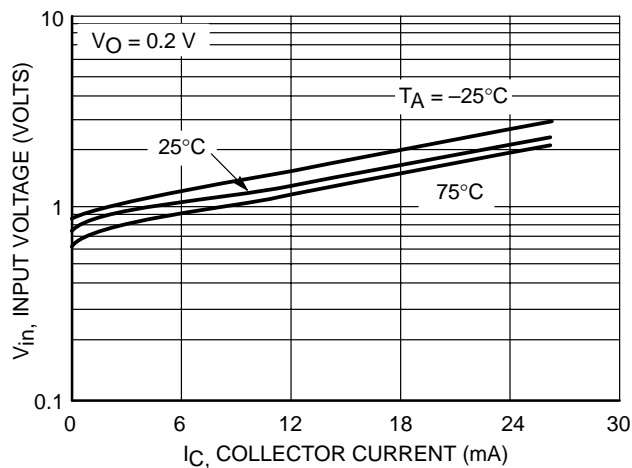

Figure 31. Input Voltage vs. Output Current

LMUN2211LT1G Series

TYPICAL ELECTRICAL CHARACTERISTICS
LMUN2234LT1G

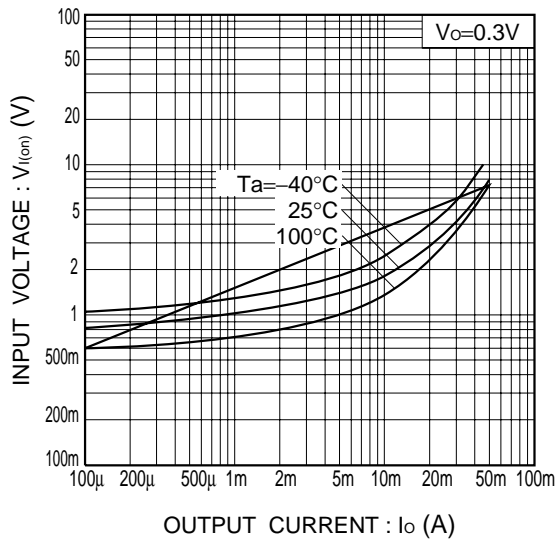

Fig.1 Input voltage vs. output current (ON characteristics)

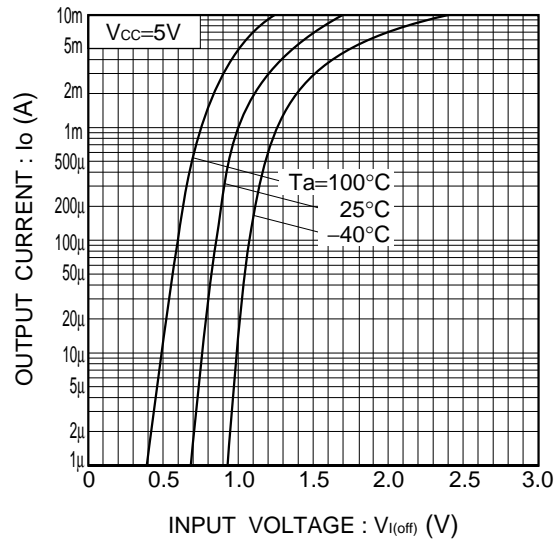

Fig.2 Output current vs. input voltage (OFF characteristics)

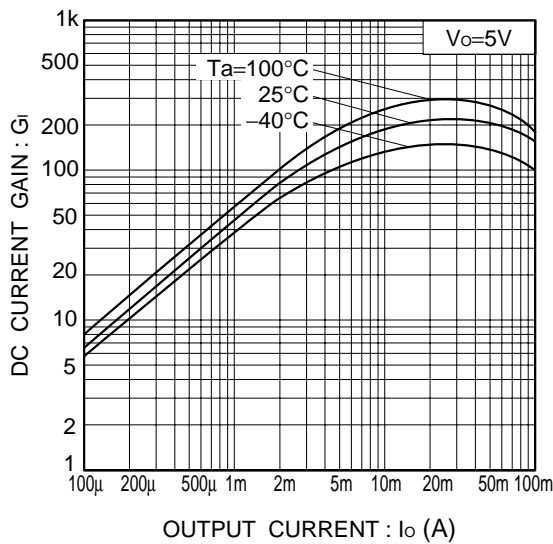

Fig.3 DC current gain vs. output current

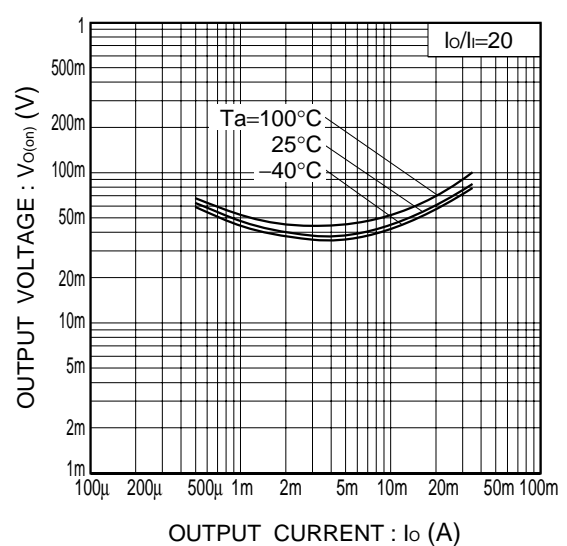

Fig.4 Output voltage vs. output current

LMUN2211LT1G Series

TYPICAL APPLICATIONS FOR NPN BRTs

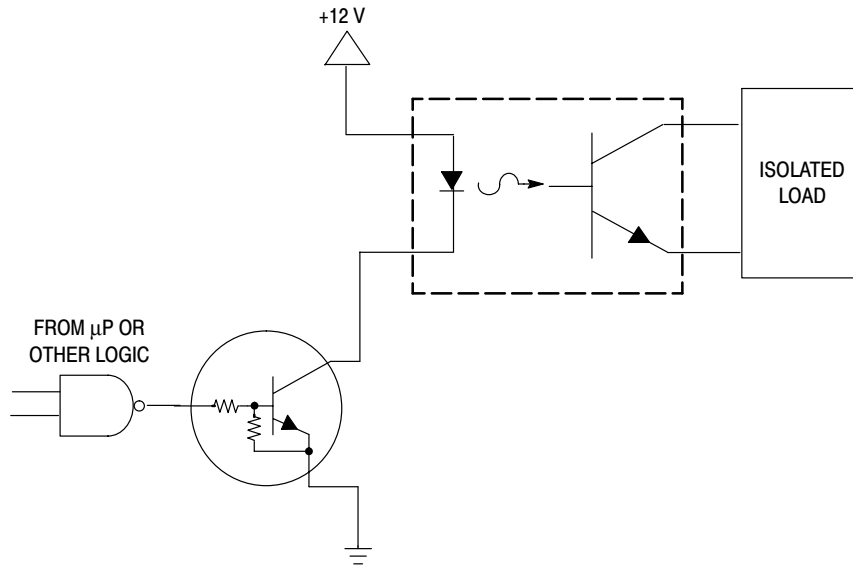

Figure 32. Level Shifter: Connects 12 or 24 Volt Circuits to Logic

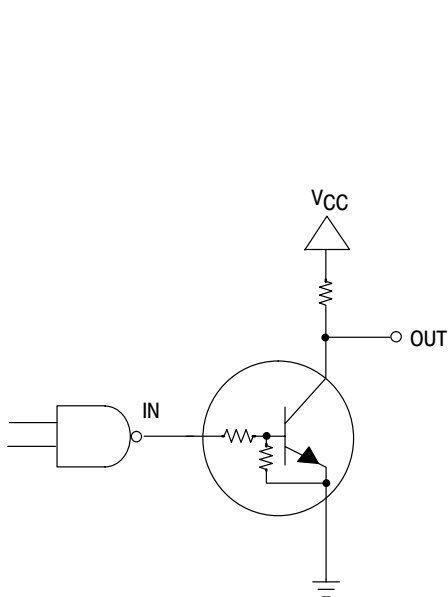

Figure 33. Open Collector Inverter: Inverts the Input Signal

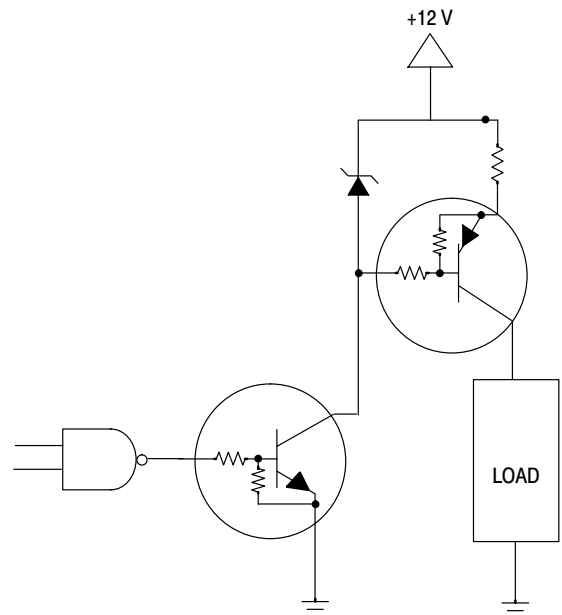
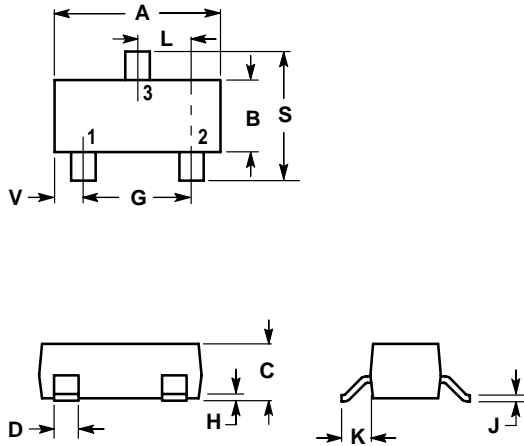

Figure 34. Inexpensive, Unregulated Current Source

LMUN2211LT1G Series

SOT-23



NOTES:

1. DIMENSIONING AND TOLERANCING PER ANSI Y14.5M, 1982.
2. CONTROLLING DIMENSION: INCH.

DIM	INCHES		MILLIMETERS	
	MIN	MAX	MIN	MAX
A	0.1102	0.1197	2.80	3.04
B	0.0472	0.0551	1.20	1.40
C	0.0350	0.0440	0.89	1.11
D	0.0150	0.0200	0.37	0.50
G	0.0701	0.0807	1.78	2.04
H	0.0005	0.0040	0.013	0.100
J	0.0034	0.0070	0.085	0.177
K	0.0140	0.0285	0.35	0.69
L	0.0350	0.0401	0.89	1.02
S	0.0830	0.1039	2.10	2.64
V	0.0177	0.0236	0.45	0.60

