

Bias Resistor Transistor

PNP Silicon Surface Mount Transistor with Monolithic Bias Resistor Network

This new series of digital transistors is designed to replace a single device and its external resistor bias network. The BRT (Bias Resistor Transistor) contains a single transistor with a monolithic bias network consisting of two resistors; a series base resistor and a base-emitter resistor. The BRT eliminates these individual components by integrating them into a single device. The use of a BRT can reduce both system cost and board space. The device is housed in the SC-70/SOT-323 package which is designed for low power surface mount applications.

- Simplifies Circuit Design
- Reduces Board Space
- Reduces Component Count
- The SC-70/SOT-323 package can be soldered using wave or reflow. The modified gull-winged leads absorb thermal stress during soldering eliminating the possibility of damage to the die.
- We declare that the material of product compliance with RoHS requirements.
- S- Prefix for Automotive and Other Applications Requiring Unique Site and Control Change Requirements; AEC-Q101 Qualified and PPAP Capable.

ORDERING INFORMATION

Device	Package	Shipping
LMUN5111T1G Series S-LMUN5111T1G Series	SOT323	3000/Tape&Reel
LMUN5111T3G Series S-LMUN5111T3G Series	SOT323	10000/Tape&Reel

MAXIMUM RATINGS (T_A = 25°C unless otherwise noted)

Rating	Symbol	Value	Unit
Collector-Base Voltage	V _{CBO}	50	Vdc
Collector-Emitter Voltage	V _{CEO}	50	Vdc
Collector Current	I _c	100	mAdc

THERMAL CHARACTERISTICS

Characteristic	Symbol	Max	Unit
Total Device Dissipation T _A = 25°C	P _D	202 (Note 1) 310 (Note 2)	mW
Derate above 25°C		1.6 (Note 1) 2.5 (Note 2)	°C/W
Thermal Resistance – Junction-to-Ambient	R _{θJA}	618 (Note 1) 403 (Note 2)	°C/W
Thermal Resistance – Junction-to-Lead	R _{θJL}	280 (Note 1) 332 (Note 2)	°C/W
Junction and Storage Temperature Range	T _J , T _{stg}	-55 to +150	°C

1. FR-4 @ Minimum Pad

2. FR-4 @ 1.0 x 1.0 inch Pad

LMUN5111T1G
Series
S-LMUN5111T1G
Series

PNP SILICON
BIAS RESISTOR
TRANSISTORS

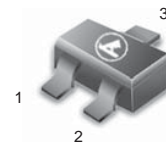

CASE 419, STYLE 3
SOT-323 (SC-70)

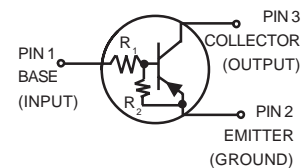

MARKING DIAGRAM

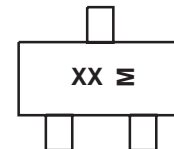

XX = Specific Device Code
M = Month Code

LMUN5111T1G Series , S-LMUM5111T1G Series**DEVICE MARKING AND RESISTOR VALUES**

Device	Package	Marking	R1 (K)	R2 (K)	Shipping
LMUN5111T1G	SC-70/SOT-323	6A	10	10	3000/Tape & Reel
LMUN5112T1G	SC-70/SOT-323	6B	22	22	3000/Tape & Reel
LMUN5113T1G	SC-70/SOT-323	P5	47	47	3000/Tape & Reel
LMUN5114T1G	SC-70/SOT-323	6D	10	47	3000/Tape & Reel
LMUN5115T1G (Note 3)	SC-70/SOT-323	6E	10	∞	3000/Tape & Reel
LMUN5116T1G (Note 3)	SC-70/SOT-323	6F	4.7	∞	3000/Tape & Reel
LMUN5130T1G (Note 3)	SC-70/SOT-323	6G	1.0	1.0	3000/Tape & Reel
LMUN5131T1G (Note 3)	SC-70/SOT-323	6H	2.2	2.2	3000/Tape & Reel
LMUN5132T1G (Note 3)	SC-70/SOT-323	6J	4.7	4.7	3000/Tape & Reel
LMUN5133T1G (Note 3)	SC-70/SOT-323	6K	4.7	47	3000/Tape & Reel
LMUN5134T1G (Note 3)	SC-70/SOT-323	6L	22	47	3000/Tape & Reel
LMUN5135T1G (Note 3)	SC-70/SOT-323	6M	2.2	47	3000/Tape & Reel
LMUN5136T1G	SC-70/SOT-323	6N	100	100	3000/Tape & Reel
LMUN5137T1G	SC-70/SOT-323	6P	47	22	3000/Tape & Reel

3. New devices. Updated curves to follow in subsequent data sheets.

LMUN5111T1G Series , S-LMUM5111T1G Series

ELECTRICAL CHARACTERISTICS ($T_A = 25^\circ\text{C}$ unless otherwise noted)

Characteristic	Symbol	Min	Typ	Max	Unit
OFF CHARACTERISTICS					
Collector–Base Cutoff Current ($V_{CB} = 50\text{ V}, I_E = 0$)	I_{CBO}	–	–	100	nAdc
Collector–Emitter Cutoff Current ($V_{CE} = 50\text{ V}, I_B = 0$)	I_{CEO}	–	–	500	nAdc
Emitter–Base Cutoff Current ($V_{EB} = 6.0\text{ V}, I_C = 0$)	LMUN5111T1G	–	–	0.5	mAdc
	LMUN5112T1G	–	–	0.2	
	LMUN5113T1G	–	–	0.1	
	LMUN5114T1G	–	–	0.2	
	LMUN5115T1G	–	–	0.9	
	LMUN5116T1G	–	–	1.9	
	LMUN5130T1G	–	–	4.3	
	LMUN5131T1G	–	–	2.3	
	LMUN5132T1G	–	–	1.5	
	LMUN5133T1G	–	–	0.18	
	LMUN5134T1G	–	–	0.13	
	LMUN5135T1G	–	–	0.2	
	LMUN5136T1G	–	–	0.05	
LMUN5137T1G	–	–	0.13		
Collector–Base Breakdown Voltage ($I_C = 10\ \mu\text{A}, I_E = 0$)	$V_{(BR)CBO}$	50	–	–	Vdc
Collector–Emitter Breakdown Voltage (Note 4) ($I_C = 2.0\text{ mA}, I_B = 0$)	$V_{(BR)CEO}$	50	–	–	Vdc

ON CHARACTERISTICS (Note 4)

DC Current Gain ($V_{CE} = 10\text{ V}, I_C = 5.0\text{ mA}$)	LMUN5111T1G	h_{FE}	35	60	–	
	LMUN5112T1G		60	100	–	
	LMUN5113T1G		80	140	–	
	LMUN5114T1G		80	140	–	
	LMUN5115T1G		160	250	–	
	LMUN5116T1G		160	250	–	
	LMUN5130T1G		3.0	5.0	–	
	LMUN5131T1G		8.0	15	–	
	LMUN5132T1G		15	27	–	
	LMUN5133T1G		80	140	–	
	LMUN5134T1G		80	130	–	
	LMUN5135T1G		80	140	–	
	LMUN5136T1G		80	150	–	
LMUN5137T1G		80	140	–		
Collector–Emitter Saturation Voltage ($I_C = 10\text{ mA}, I_E = 0.3\text{ mA}$) ($I_C = 10\text{ mA}, I_B = 5\text{ mA}$) LMUN5130T1G/LMUN5131T1G ($I_C = 10\text{ mA}, I_B = 1\text{ mA}$) LMUN5115T1G/LMUN5116T1G/ LMUN5132T1G/LMUN5134T1G	$V_{CE(sat)}$	–	–	0.25	Vdc	
Output Voltage (on) ($V_{CC} = 5.0\text{ V}, V_B = 2.5\text{ V}, R_L = 1.0\text{ k}\Omega$)	LMUN5111T1G	V_{OL}	–	–	0.2	Vdc
	LMUN5112T1G		–	–	0.2	
	LMUN5114T1G		–	–	0.2	
	LMUN5115T1G		–	–	0.2	
	LMUN5116T1G		–	–	0.2	
	LMUN5130T1G		–	–	0.2	
	LMUN5131T1G		–	–	0.2	
	LMUN5132T1G		–	–	0.2	
	LMUN5133T1G		–	–	0.2	
	LMUN5134T1G		–	–	0.2	
	LMUN5135T1G		–	–	0.2	
	($V_{CC} = 5.0\text{ V}, V_B = 3.5\text{ V}, R_L = 1.0\text{ k}\Omega$) LMUN5113T1G		–	–	0.2	
	($V_{CC} = 5.0\text{ V}, V_B = 5.5\text{ V}, R_L = 1.0\text{ k}\Omega$) LMUN5136T1G		–	–	0.2	
($V_{CC} = 5.0\text{ V}, V_B = 4.0\text{ V}, R_L = 1.0\text{ k}\Omega$) LMUN5137T1G	–	–	0.2			

4. Pulse Test: Pulse Width < 300 μs , Duty Cycle < 2.0%

LMUN5111T1G Series , S-LMUM5111T1G Series

ELECTRICAL CHARACTERISTICS ($T_A = 25^\circ\text{C}$ unless otherwise noted) (Continued)

Characteristic	Symbol	Min	Typ	Max	Unit
Output Voltage (off) ($V_{CC} = 5.0\text{ V}$, $V_B = 0.5\text{ V}$, $R_L = 1.0\text{ k}\Omega$) ($V_{CC} = 5.0\text{ V}$, $V_B = 0.050\text{ V}$, $R_L = 1.0\text{ k}\Omega$) ($V_{CC} = 5.0\text{ V}$, $V_B = 0.25\text{ V}$, $R_L = 1.0\text{ k}\Omega$)	V_{OH}	4.9	–	–	Vdc
Input Resistor	R1	7.0	10	13	k Ω
LMUN5111T1G		15.4	22	28.6	
LMUN5112T1G		32.9	47	61.1	
LMUN5113T1G		7.0	10	13	
LMUN5114T1G		7.0	10	13	
LMUN5115T1G		3.3	4.7	6.1	
LMUN5116T1G		0.7	1.0	1.3	
LMUN5130T1G		1.5	2.2	2.9	
LMUN5131T1G		3.3	4.7	6.1	
LMUN5132T1G		3.3	4.7	6.1	
LMUN5133T1G		15.4	22	28.6	
LMUN5134T1G		1.54	2.2	2.86	
LMUN5135T1G		70	100	130	
LMUN5136T1G		32.9	47	61.1	
LMUN5137T1G					
Resistor Ratio	R_1/R_2				
LMUN5111T1G/LMUN5112T1G/LMUN5113T1G/ LMUN5136T1G		0.8	1.0	1.2	
LMUN5114T1G		0.17	0.21	0.25	
LMUN5115T1G/LMUN5116T1G		–	–	–	
LMUN5130T1G/LMUN5131T1G/LMUN5132T1G		0.8	1.0	1.2	
LMUN5133T1G		0.055	0.1	0.185	
LMUN5134T1G		0.38	0.47	0.56	
LMUN5135T1G		0.038	0.047	0.056	
LMUN5137T1G		1.7	2.1	2.6	

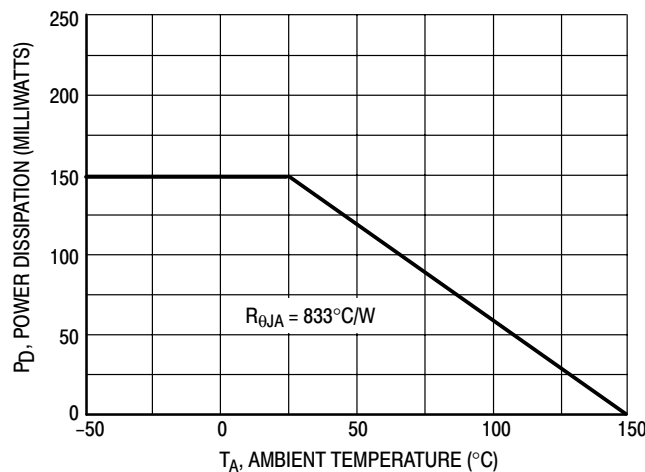

Figure 1. Derating Curve

LMUN5111T1G Series , S-LMUM5111T1G Series

TYPICAL ELECTRICAL CHARACTERISTICS – LMUN5111T1G

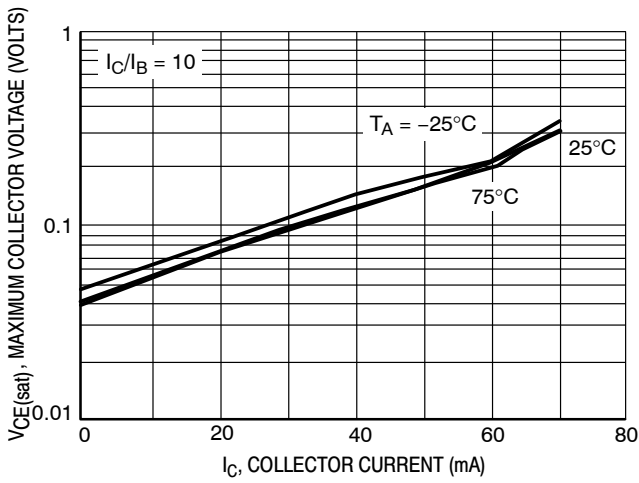

Figure 2. $V_{CE(sat)}$ versus I_C

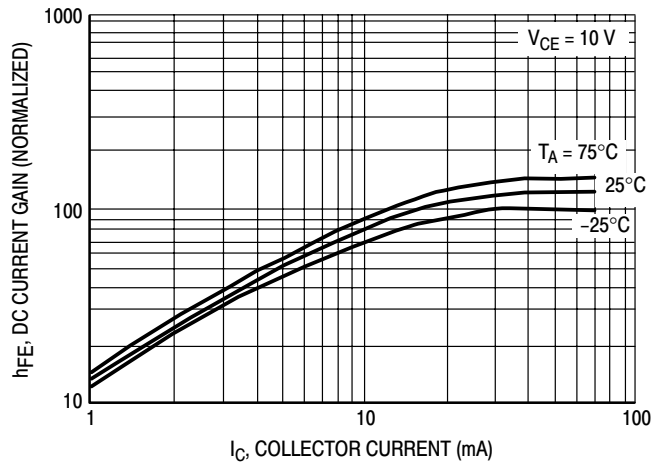

Figure 3. DC Current Gain

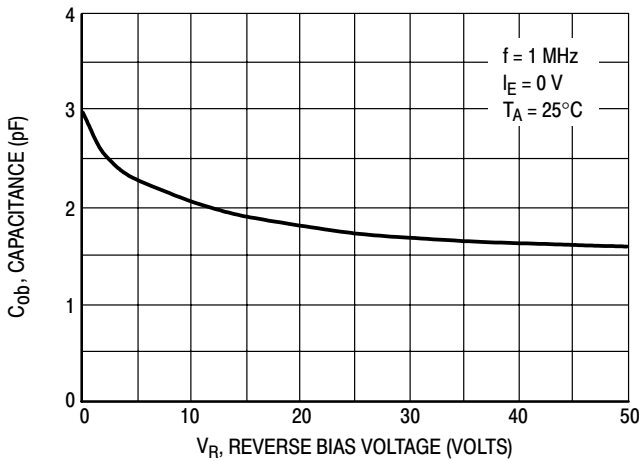

Figure 4. Output Capacitance

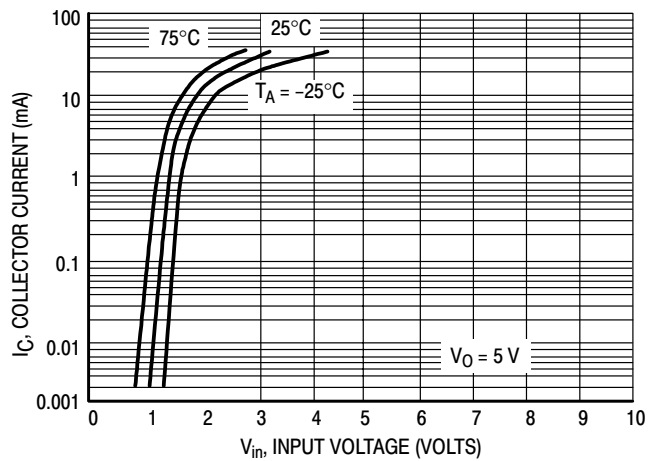

Figure 5. Output Current versus Input Voltage

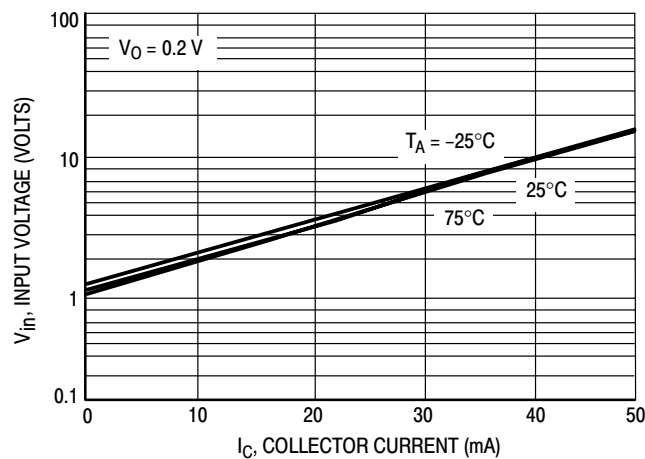

Figure 6. Input Voltage versus Output Current

LMUN5111T1G Series , S-LMUM5111T1G Series

TYPICAL ELECTRICAL CHARACTERISTICS – LMUN5112T1G

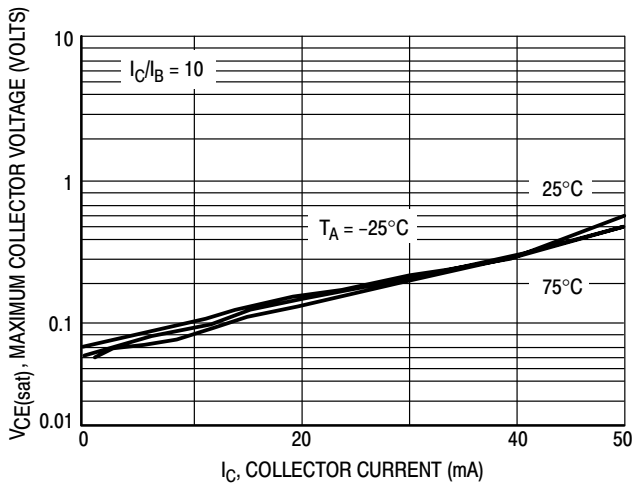

Figure 7. $V_{CE(sat)}$ versus I_C

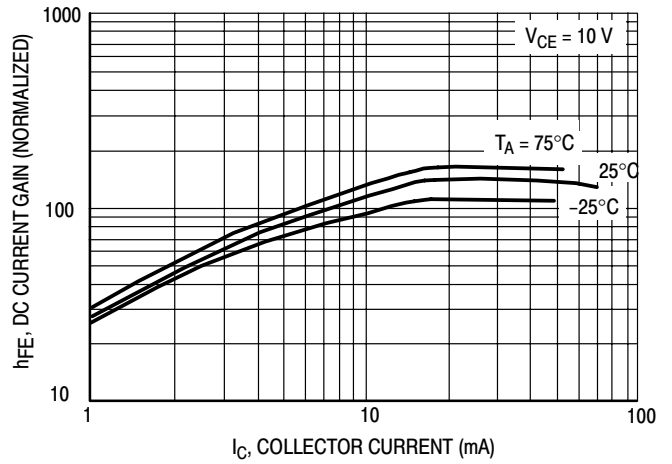

Figure 8. DC Current Gain

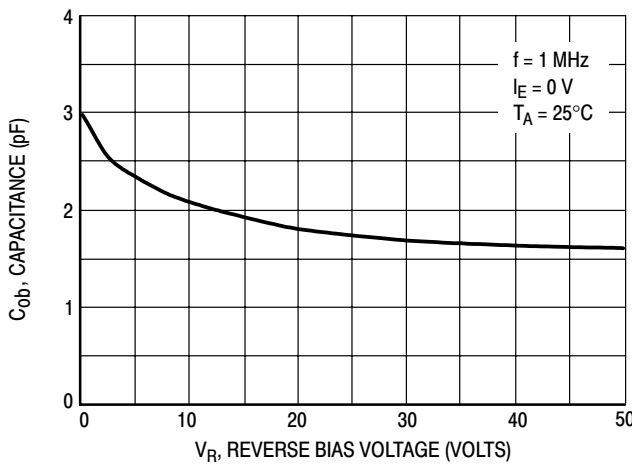

Figure 9. Output Capacitance

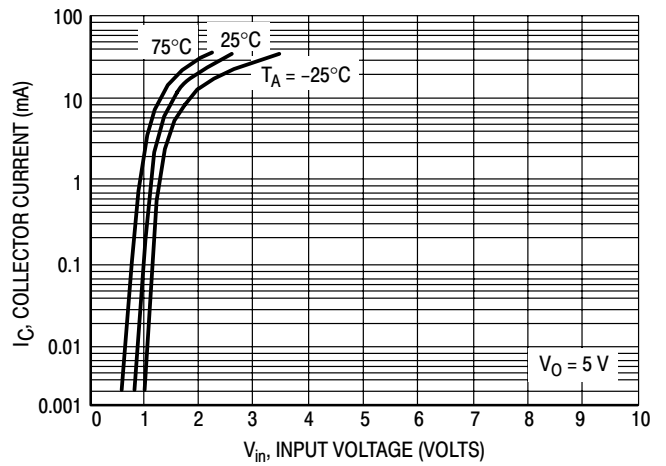

Figure 10. Output Current versus Input Voltage

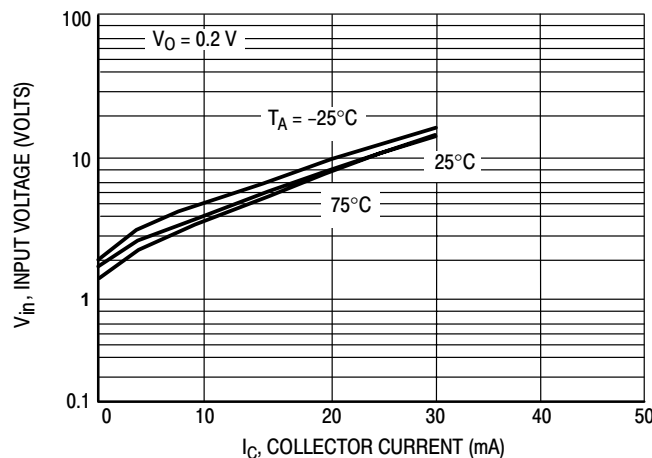

Figure 11. Input Voltage versus Output Current

LMUN5111T1G Series , S-LMUM5111T1G Series

TYPICAL ELECTRICAL CHARACTERISTICS – LMUN5113T1G

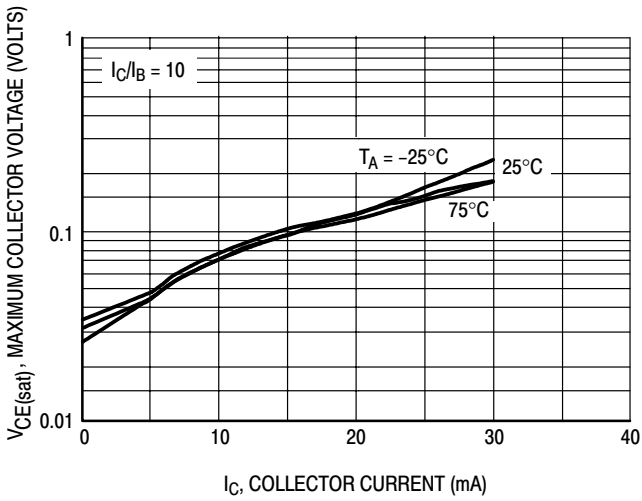

Figure 12. $V_{CE(sat)}$ versus I_C

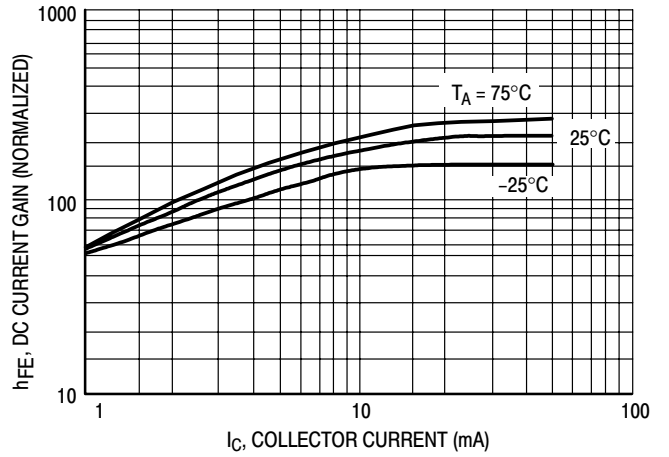

Figure 13. DC Current Gain

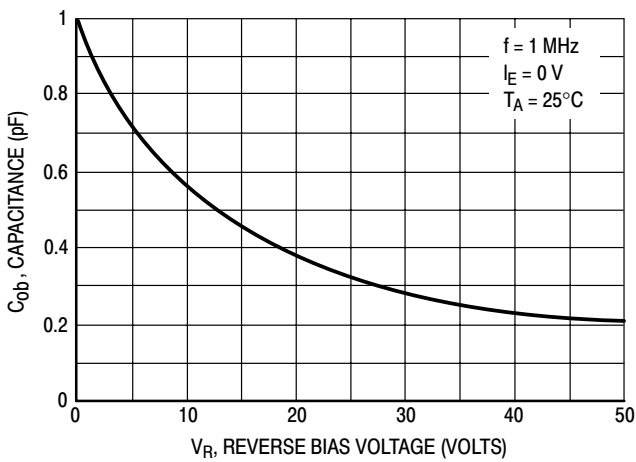

Figure 14. Output Capacitance

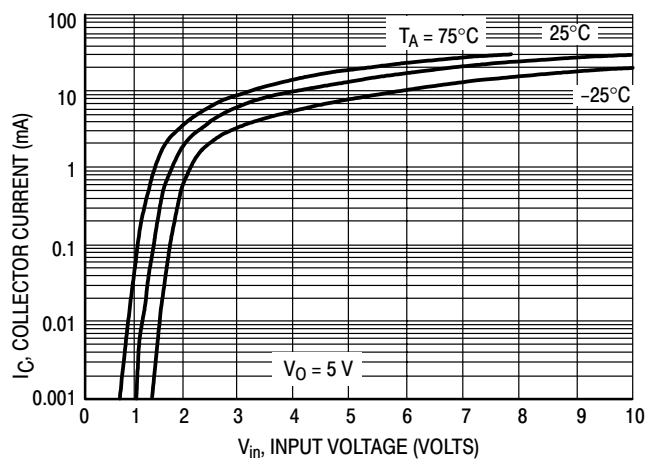

Figure 15. Output Current versus Input Voltage

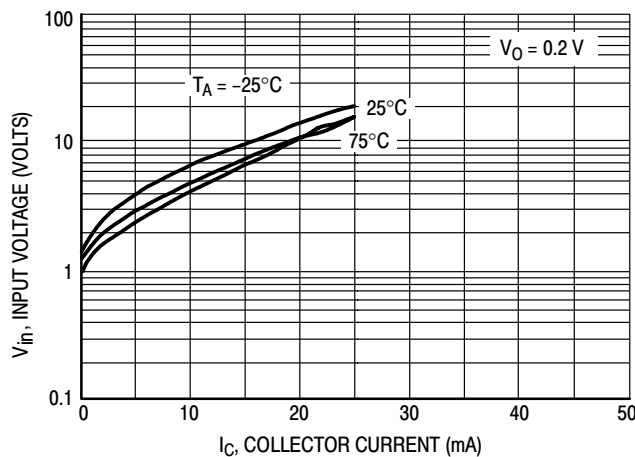

Figure 16. Input Voltage versus Output Current

LMUN5111T1G Series , S-LMUM5111T1G Series

TYPICAL ELECTRICAL CHARACTERISTICS – LMUN5114T1G

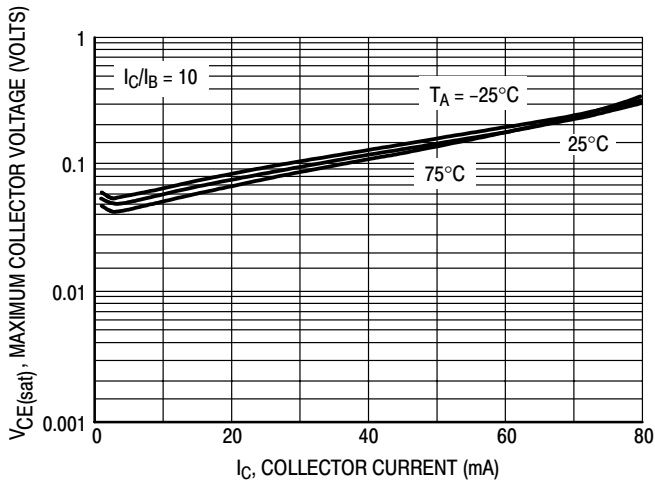

Figure 17. $V_{CE(sat)}$ versus I_C

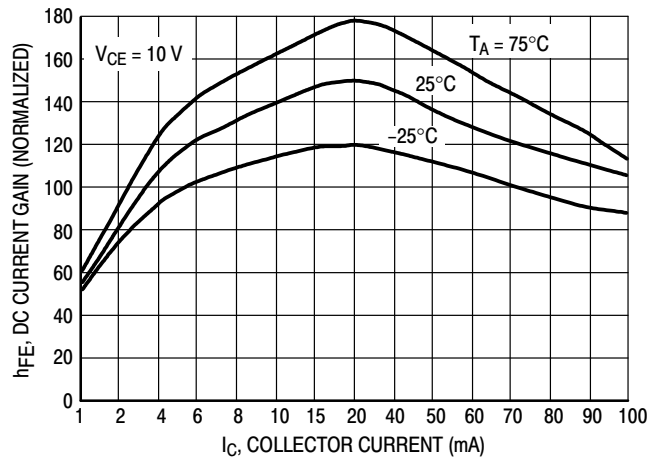

Figure 18. DC Current Gain

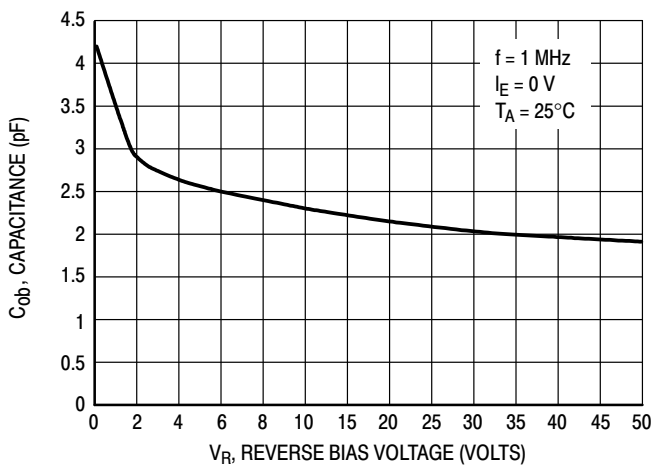

Figure 19. Output Capacitance

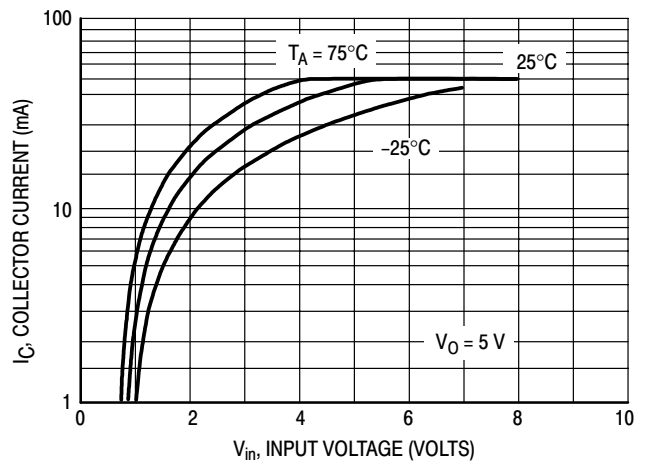

Figure 20. Output Current versus Input Voltage

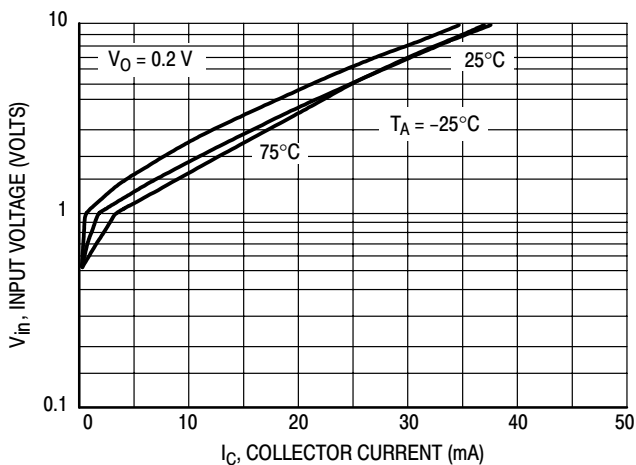

Figure 21. Input Voltage versus Output Current

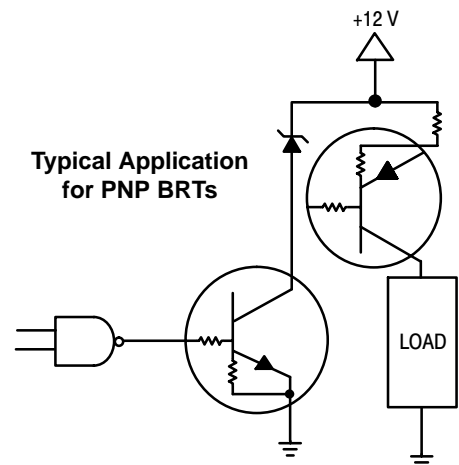

Figure 22. Inexpensive, Unregulated Current Source

LMUN5111T1G Series , S-LMUM5111T1G Series

TYPICAL ELECTRICAL CHARACTERISTICS — LMUN5132T1G

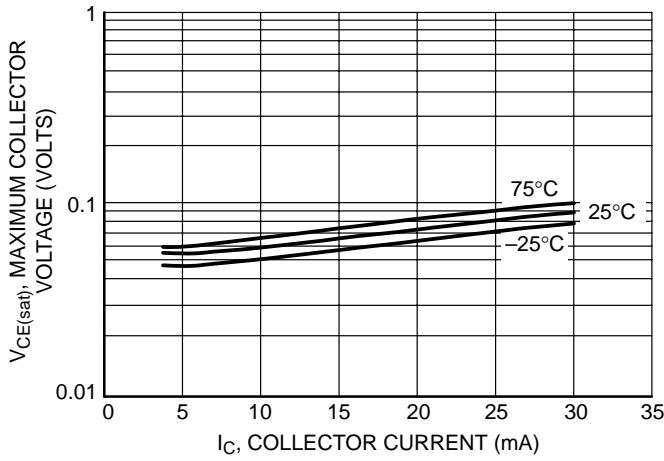

Figure 23. Maximum Collector Voltage versus Collector Current

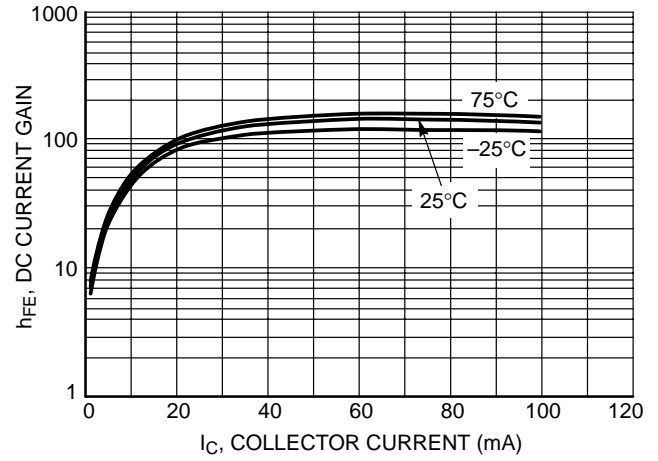

Figure 24. DC Current Gain

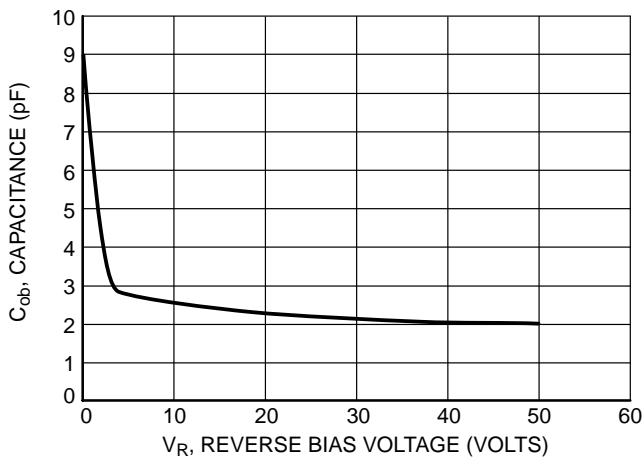

Figure 25. Output Capacitance

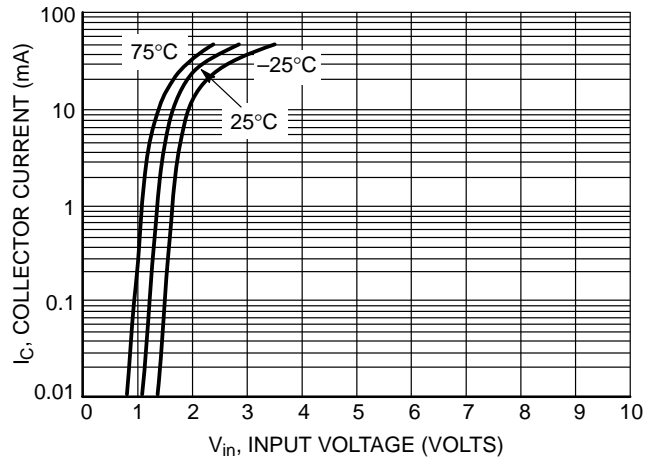

Figure 26. Output Current versus Input Voltage

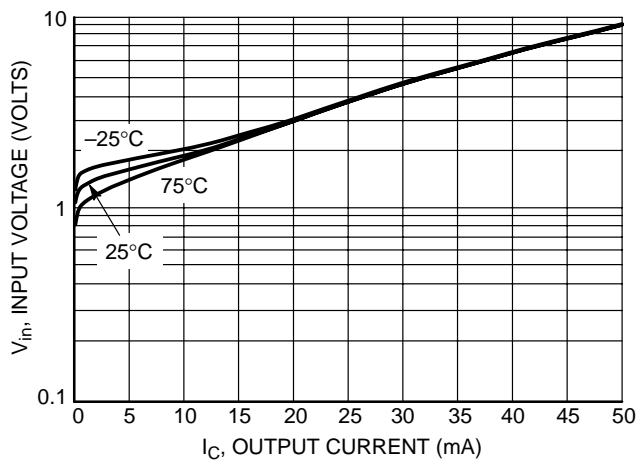

Figure 27. Input Voltage versus Output Current

LMUN5111T1G Series , S-LMUM5111T1G Series

TYPICAL ELECTRICAL CHARACTERISTICS — LMUN5136T1G

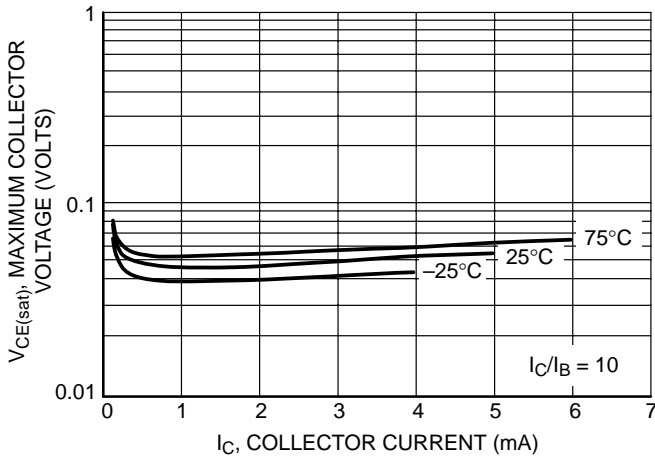

Figure 28. Maximum Collector Voltage versus Collector Current

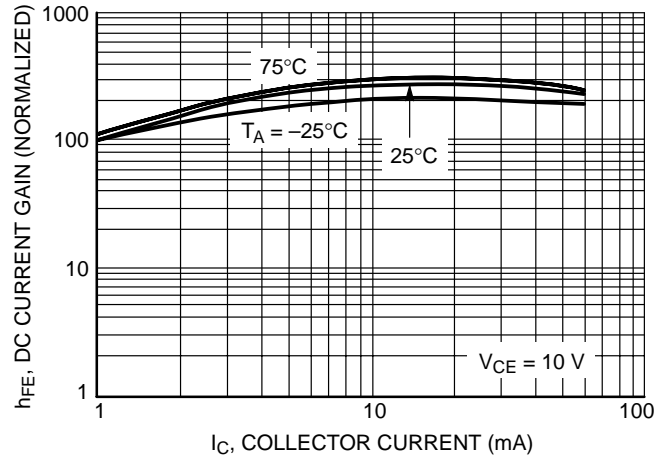

Figure 29. DC Current Gain

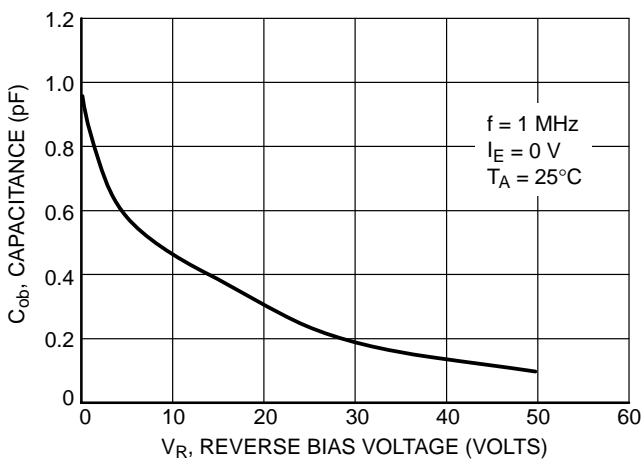

Figure 30. Output Capacitance

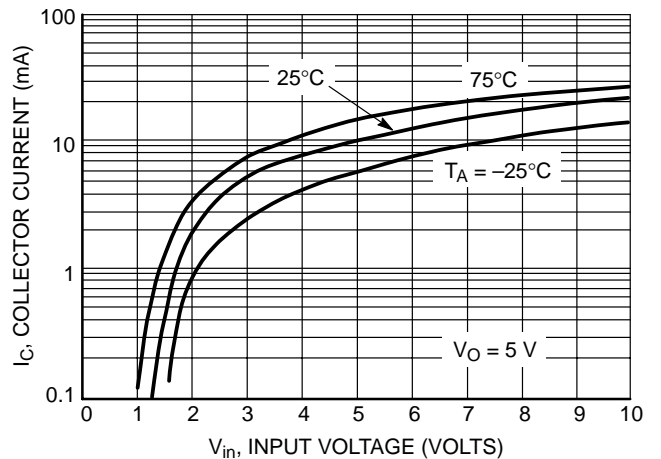

Figure 31. Output Current versus Input Voltage

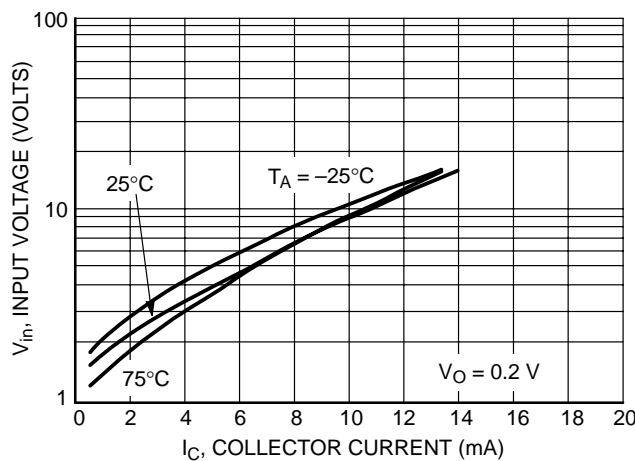

Figure 32. Input Voltage versus Output Current

LMUN5111T1G Series , S-LMUM5111T1G Series

TYPICAL ELECTRICAL CHARACTERISTICS — LMUN5137T1G

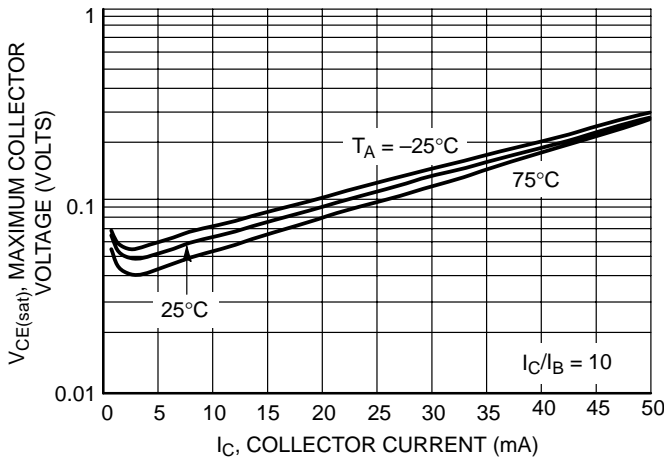

Figure 33. Maximum Collector Voltage versus Collector Current

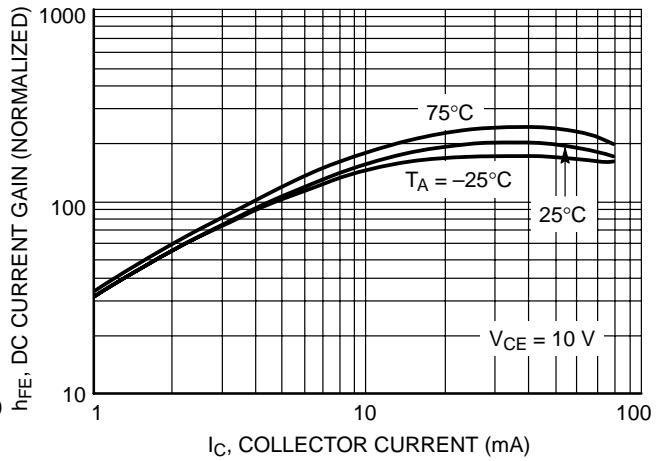

Figure 34. DC Current Gain

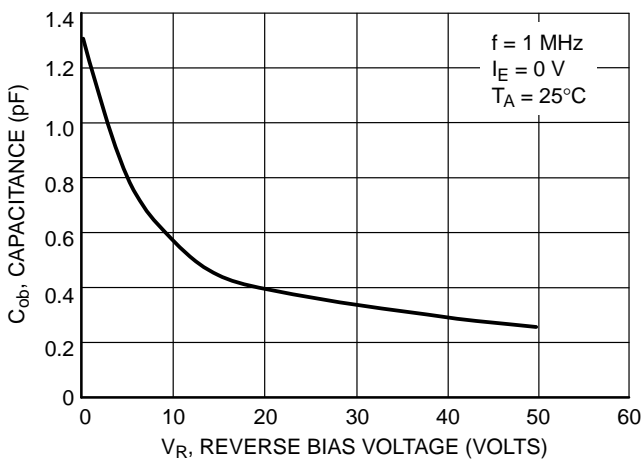

Figure 35. Output Capacitance

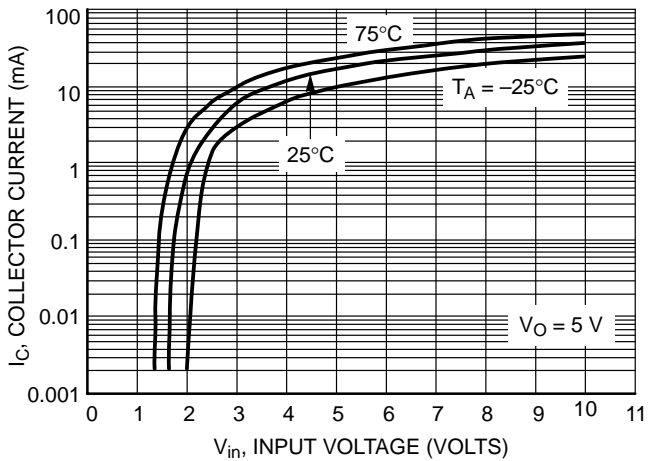

Figure 36. Output Current versus Input Voltage

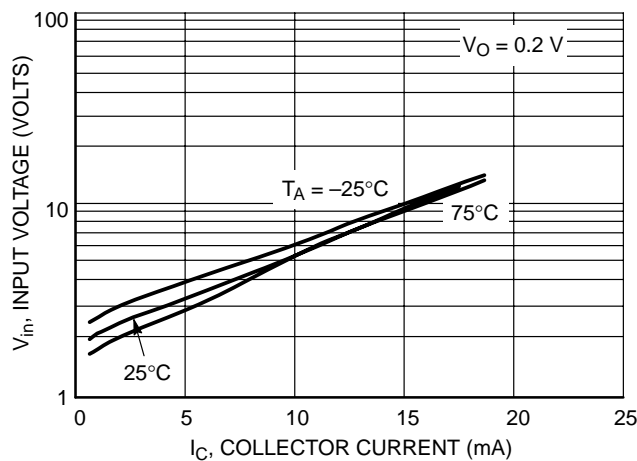
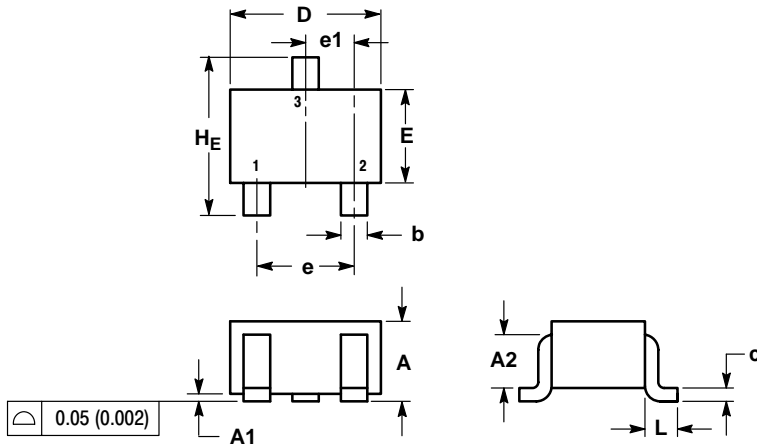

Figure 37. Input Voltage versus Output Current

LMUN5111T1G Series , S-LMUM5111T1G Series

SC-70 (SOT-323)



NOTES:
 1. DIMENSIONING AND TOLERANCING PER ANSI Y14.5M, 1982.
 2. CONTROLLING DIMENSION: INCH.

DIM	MILLIMETERS			INCHES		
	MIN	NOM	MAX	MIN	NOM	MAX
A	0.80	0.90	1.00	0.032	0.035	0.040
A1	0.00	0.05	0.10	0.000	0.002	0.004
A2	0.7 REF			0.028 REF		
b	0.30	0.35	0.40	0.012	0.014	0.016
c	0.10	0.18	0.25	0.004	0.007	0.010
D	1.80	2.10	2.20	0.071	0.083	0.087
E	1.15	1.24	1.35	0.045	0.049	0.053
e	1.20	1.30	1.40	0.047	0.051	0.055
e1	0.65 BSC			0.026 BSC		
L	0.425 REF			0.017 REF		
HE	2.00	2.10	2.40	0.079	0.083	0.095

GENERIC MARKING DIAGRAM

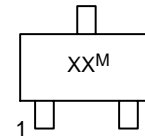

- XX = Specific Device Code
- M = Date Code
- = Pb-Free Package

*This information is generic. Please refer to device data sheet for actual part marking. Pb-Free indicator, "G" or microdot "▪", may or may not be present.

SOLDERING FOOTPRINT*

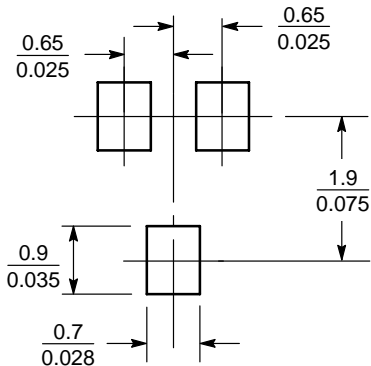

SCALE 10:1 (mm/inches)