

LRB751S-40T1G

S-LRB751S-40T1G

Schottky Barrier Diode

1. FEATURES

- We declare that the material of product compliance with RoHS requirements and Halogen Free.
- S- prefix for automotive and other applications requiring unique site and control change requirements; AEC-Q101 qualified and PPAP capable.
- Low reverse current and low forward voltage.
- High reliability

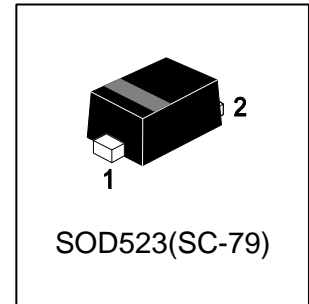

2. APPLICATIONS

- Silicon epitaxial planar

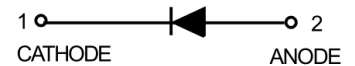

3. DEVICE MARKING AND ORDERING INFORMATION

Device	Marking	Shipping
LRB751S-40T1G	5	3000/Tape&Reel
LRB751S-40T5G	5	8000/Tape&Reel

4. MAXIMUM RATINGS(Ta = 25°C)

Parameter	Symbol	Limits	Unit
Peak Reverse Voltage	VRM	40	V
DC Reverse Voltage	VR	30	V
Mean Rectifying Current	IO	30	mA
Peak Forward Surge Current	IFSM	200	mA
Junction temperature	TJ	125	°C
Storage temperature	Tstg	-40~+125	°C

5. ELECTRICAL CHARACTERISTICS (Ta= 25°C)

Characteristic	Symbol	Min.	Typ.	Max.	Unit
Forward voltage(IF=1mA)	VF	-	-	0.37	V
Reverse Current(VR=30V)	IR	-	-	0.5	μA
Diode Capacitance(VR = 1V, f = 1.0 MHz)	CT	-	2	-	pF

6.ELECTRICAL CHARACTERISTICS CURVES

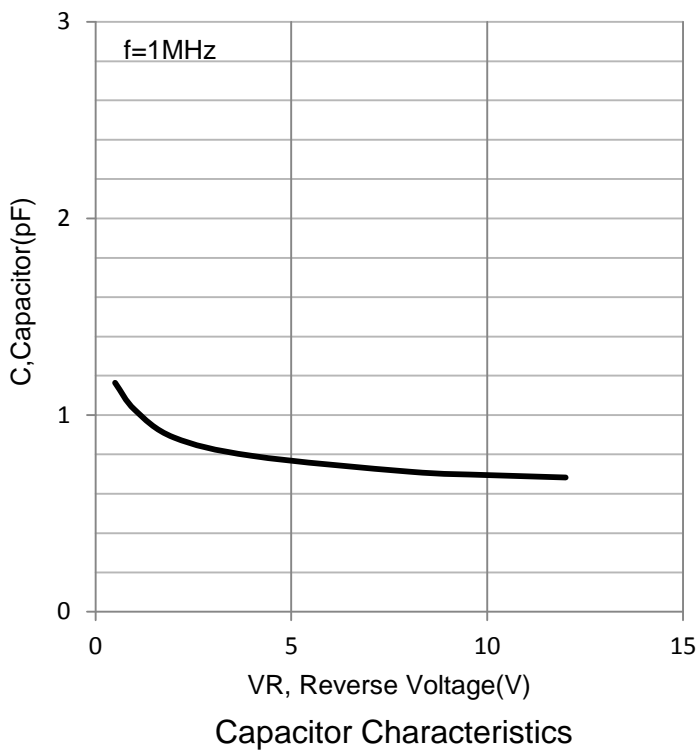
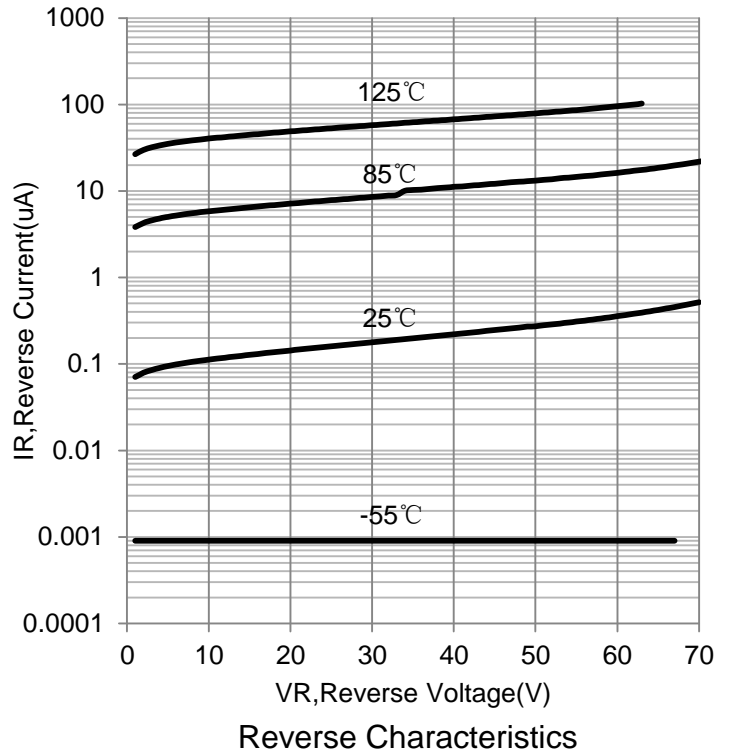
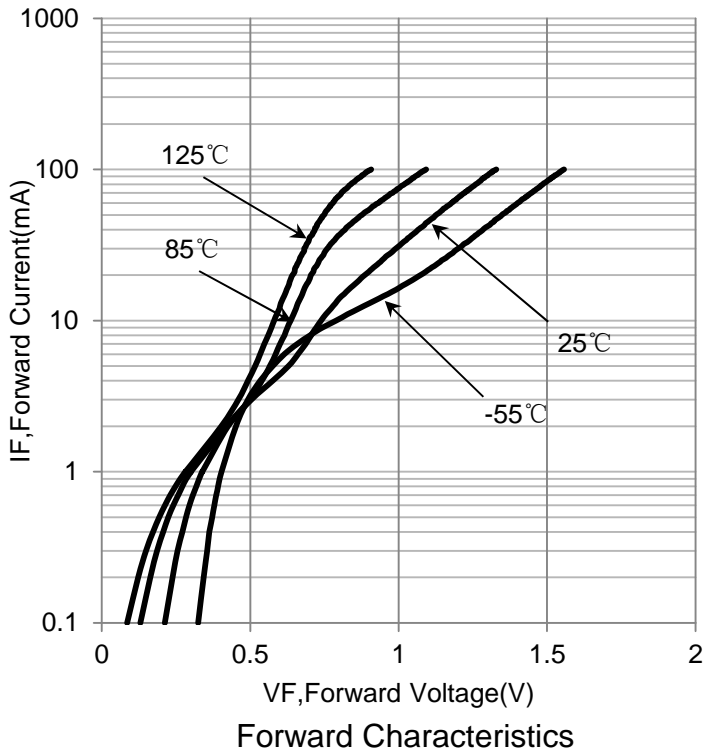

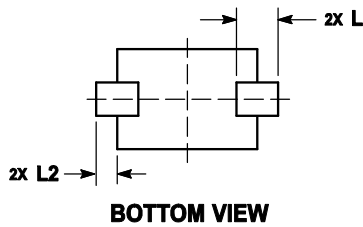
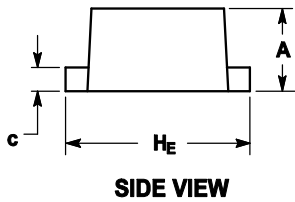
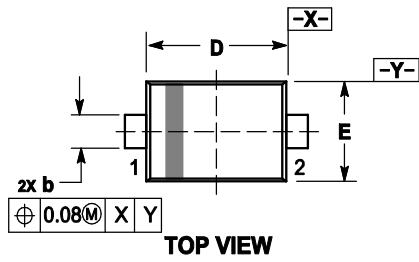
7. OUTLINE AND DIMENSIONS

Notes:

1. DIMENSIONING AND TOLERANCING PER ANSI Y14.5M, 1982.
2. CONTROLLING DIMENSION: MILLIMETERS.
3. MAXIMUM LEAD THICKNESS INCLUDES LEAD FINISH. MINIMUM LEAD THICKNESS IS THE MINIMUM THICKNESS OF BASE MATERIAL.
4. DIMENSIONS D AND E DO NOT INCLUDE MOLD FLASH, PROTRUSIONS OR GATE BURRS.

DIM	MILLIMETERS			INCHES		
	MIN	NOM	MAX	MIN	NOM	MAX
A	0.50	0.60	0.70	0.020	0.024	0.028
b	0.25	0.30	0.35	0.010	0.012	0.014
c	0.07	0.14	0.20	0.003	0.006	0.008
D	1.10	1.20	1.30	0.043	0.047	0.051
E	0.70	0.80	0.90	0.028	0.031	0.035
H _E	1.50	1.60	1.70	0.059	0.063	0.067
L	0.30 REF			0.012 REF		
L ₂	0.15	0.20	0.25	0.006	0.008	0.010

8. SOLDERING FOOTPRINT
