

3QL150AK Thru 3QL150AS

1. 外型尺寸 Feature & Dimension

Features

- I Package with screw terminals
- I Isolation voltage 3000 V~
- I Glass passivated chips
- I Blocking voltage up to 1600 V
- I Low forward voltage drop
- I UL registered E231047

Applications

- I Supplies for DC power equipment
- I Input rectifiers for PWM inverter
- I Battery DC power supplies
- I Field supply for DC motors

Advantages

- I Easy to mount with two screws
- I Space and weight savings
- I Improved temperature and power cycling

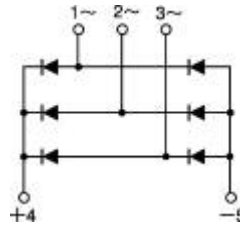
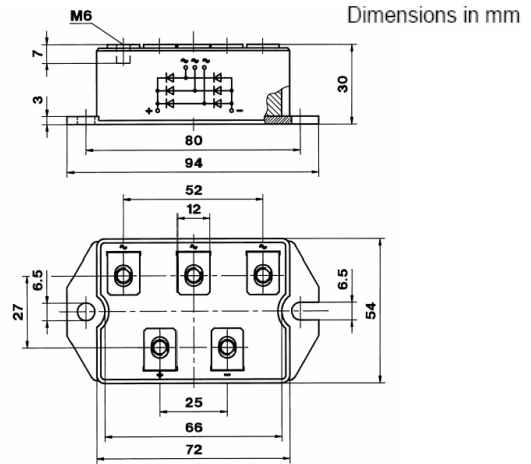

2. 产品性能 Product Characteristic

ELECTRICAL AND THERMAL CHARACTERISTICS

TC=25°C unless otherwise specified

Item	Symbol	3QL150AK	3QL150AO	3QL150AQ	3QL150AS	Unit
Maximum repetitive voltage	VRM	800	1200	1400	1600	V
Maximum RMS Voltage	VRMS	560	840	980	1120	V
Maximum DC Blocking Voltage	VDC	800	1200	1400	1600	V
Peak Reverse Current (per leg) @Tj = 25°C At Rated DC Blocking Voltage @Tj = 150°C	IR	≤10				uA
		≤20				mA
Average recified forward current 60Hz sine wave,R-load with heatsink Tc=100°C	Io	150				A
TJ=45°C VR=0 t=10ms (50Hz),sine t=8.3ms(60Hz),sine TJ=150°C VR=0 t=10ms (50Hz),sine t=8.3ms(60Hz),sine	IFSM	1500				A
		1700				
		1350				
		1500				
TJ=45°C VR=0 t=10ms (50Hz),sine t=8.3ms(60Hz),sine TJ=150°C VR=0 t=10ms (50Hz),sine t=8.3ms(60Hz),sine	I ² t	11250				A ² s
		14450				
		9100				
		11250				

3QL150AK Thru 3QL150AS

Storage temperature	Tstg	-40 to +150	°C
50/60Hz RMS t=1 min IISOL≤1mA t=1 s	VISOL	2500 3000	V~
Mounting torque(M5) Terminal connection torque(M5)	Md	(Recommended Value 1.5~2.5) 5±15%	N·m
typical	Weight	270	g
I _F =200A T _J =25°C	V _F	1.3	V
For power-loss calculations only	V _{T0}	0.8	V
per diode DC current Per module	R _{thJC}	0.6 0.1	k/w k/w
per diode DC current(typ.) per module(typ.)	R _{thCS}	0.18 0.03	k/w k/w
Creeping distance on surface	dS	10	mm
Creeping distance in air	dA	9.4	mm
Max. allowable acceleration	a	50	m/s ²

3QL150AK Thru 3QL150AS

3. 特性曲线 Characteristic Curve

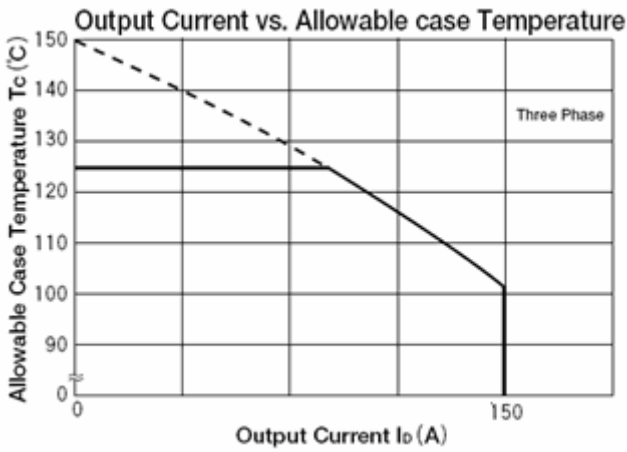

Fig.1. Power dissipation vs. output current

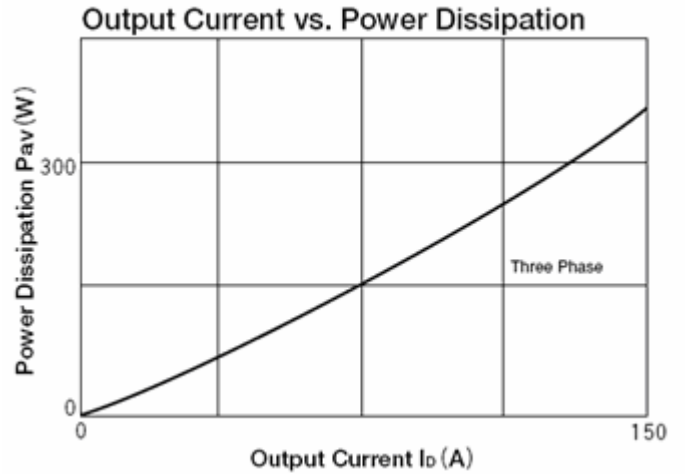

Fig.2 Power dissipation vs. Power Dissipation

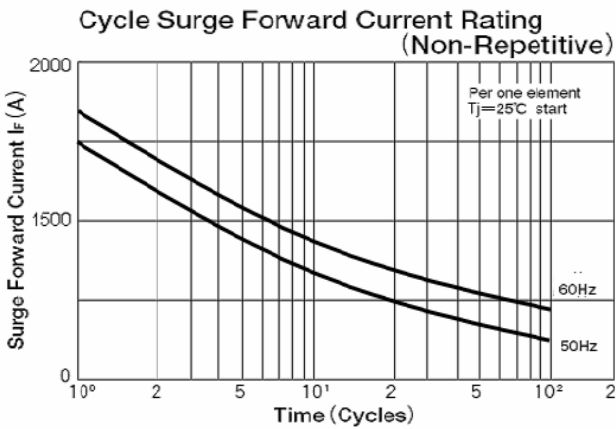

Fig.3. Surge overload characteristics vs. time

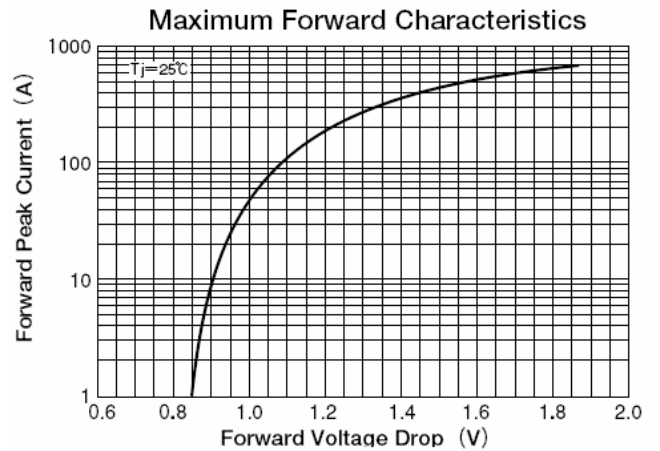

Fig.4. Forward characteristics of a diode arm

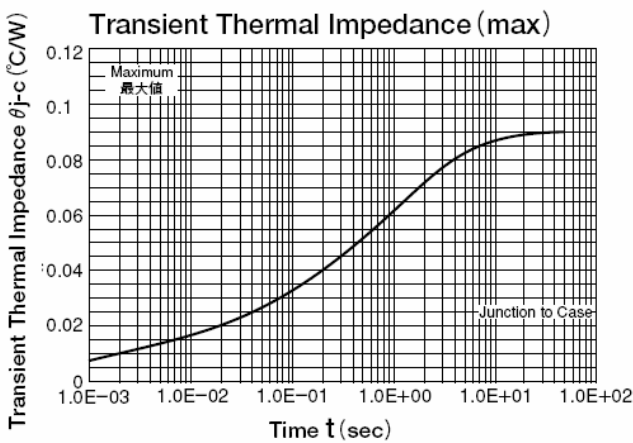
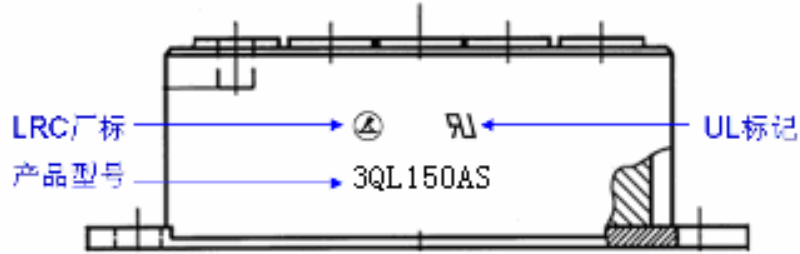

Fig.5. Transient thermal impedance vs. time

3QL150AK Thru 3QL150AS

4. 印字规范 Marking Identification



Note:

型号: **3** **QL** **150** **AS**

→ Bridge reverse voltage=1600V
 → Average rectified forward Current=150A
 → mean: QL series bridge
 → mean: Three phase bridge