

NLV17SZ04

Single Inverter

The NLV17SZ04 is an inverter in three tiny footprint packages. The device performs much as LCX multi-gate products in speed and drive.

Features

- Tiny SOT-353 Package
- 24 mA Sink and Source Output Capability
- Over-Voltage Tolerant Inputs and Outputs
- Pin For Pin with NC7SZ04P5X, TC7SZ04FU
- Chip Complexity: FETs = 20
- Designed for 1.65 V to 5.5 V V_{CC} Operation
- NLV Prefix for Automotive and Other Applications Requiring Unique Site and Control Change Requirements; AEC-Q100 Qualified and PPAP Capable
- These Devices are Pb-Free, Halogen Free/BFR Free and are RoHS Compliant

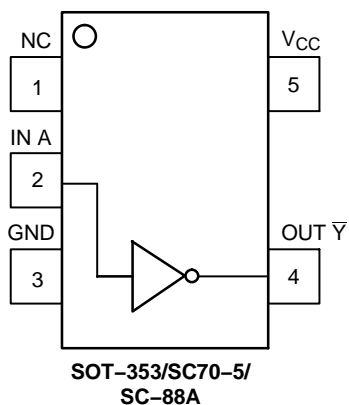

Figure 1. Pinout (Top View)

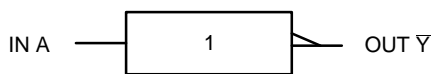
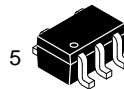

Figure 2. Logic Symbol



ON Semiconductor®

www.onsemi.com



SOT-353/SC70-5/SC-88A
DF SUFFIX
CASE 419A

MARKING DIAGRAMS

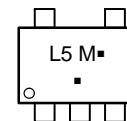

L5 = Specific Device Marking
M = Date Code*
■ = Pb-Free Package

(Note: Microdot may be in either location)

*Date Code orientation and/or position may vary depending upon manufacturing location.

ORDERING INFORMATION

See detailed ordering and shipping information in the package dimensions section on page 4 of this data sheet.

NLV17SZ04

PIN ASSIGNMENT (SOT-353/SC70-5/SC-88A)

Pin	Function
1	NC
2	IN A
3	GND
4	OUT \bar{Y}
5	V_{CC}

FUNCTION TABLE

Input	Output
A	\bar{Y}
L	H
H	L

MAXIMUM RATINGS

Symbol	Parameter	Value	Unit
V_{CC}	DC Supply Voltage	-0.5 to +7.0	V
V_I	DC Input Voltage	$-0.5 \leq V_I \leq +7.0$	V
V_O	DC Output Voltage Output in Higher or Low State (Note 1)	-0.5 to $V_{CC} + 0.5$	V
I_{IK}	DC Input Diode Current $V_I < GND$	-50	mA
I_{OK}	DC Output Diode Current $V_O < GND, V_O > V_{CC}$	± 50	mA
I_O	DC Output Sink Current	± 50	mA
I_{CC}	DC Supply Current per Supply Pin	± 100	mA
I_{GND}	DC Ground Current per Supply Pin	± 100	mA
T_{STG}	Storage Temperature Range	-65 to +150	$^{\circ}C$
T_L	Lead Temperature, 1 mm from Case for 10 Seconds	260	$^{\circ}C$
T_J	Junction Temperature Under Bias	+150	$^{\circ}C$
θ_{JA}	Thermal Resistance (Note 2)	350	$^{\circ}C/W$
P_D	Power Dissipation in Still Air at 85 $^{\circ}C$	186	mW
MSL	Moisture Sensitivity	Level 1	
F_R	Flammability Rating Oxygen Index: 28 to 34	UL 94 V-0 @ 0.125 in	
ESD	ESD Classification Human Body Model (Note 3) Machine Model (Note 4) Charged Device Model (Note 5)	Class 2 Class C N/A	
$I_{LATCHUP}$	Latchup Performance Above V_{CC} and Below GND at 125 $^{\circ}C$ (Note 6)	± 100	mA

Stresses exceeding those listed in the Maximum Ratings table may damage the device. If any of these limits are exceeded, device functionality should not be assumed, damage may occur and reliability may be affected.

- IO absolute maximum rating must be observed.
- Measured with minimum pad spacing on an FR4 board, using 10 mm-by-1 inch, 2-ounce copper trace with no air flow.
- Tested to EIA/JESD22-A114-A, rated to EIA/JESD22-A114-B.
- Tested to EIA/JESD22-A115-A, rated to EIA/JESD22-A115-A.
- Tested to JESD22-C101-A.
- Tested to EIA/JESD78.

NLV17SZ04

RECOMMENDED OPERATING CONDITIONS

Symbol	Parameter	Min	Max	Unit
V_{CC}	DC Supply Voltage	1.65 1.5	5.5 5.5	V
V_{IN}	DC Input Voltage	0	5.5	V
V_{OUT}	DC Output Voltage (High or Low State)	0	5.5	V
T_A	Operating Temperature Range	-55	+125	°C
t_r, t_f	Input Rise and Fall Time	0 0 0	20 10 5	ns/V
		$V_{CC} = 2.5\text{ V} \pm 0.2\text{ V}$ $V_{CC} = 3.0\text{ V} \pm 0.3\text{ V}$ $V_{CC} = 5.0\text{ V} \pm 0.5\text{ V}$		

Functional operation above the stresses listed in the Recommended Operating Ranges is not implied. Extended exposure to stresses beyond the Recommended Operating Ranges limits may affect device reliability.

DC ELECTRICAL CHARACTERISTICS

Symbol	Parameter	Condition	V_{CC} (V)	$T_A = 25^\circ\text{C}$			$-55^\circ\text{C} \leq T_A \leq 125^\circ\text{C}$		Unit
				Min	Typ	Max	Min	Max	
V_{IH}	High-Level Input Voltage		1.65 to 1.95 2.3 to 5.5	$0.75 V_{CC}$ $0.7 V_{CC}$			$0.75 V_{CC}$ $0.7 V_{CC}$		V
V_{IL}	Low-Level Input Voltage		1.65 to 1.95 2.3 to 5.5			$0.25 V_{CC}$ $0.3 V_{CC}$		$0.25 V_{CC}$ $0.3 V_{CC}$	V
V_{OH}	High-Level Output Voltage $V_{IN} = V_{IL}$	$I_{OH} = -100\ \mu\text{A}$	1.65 to 5.5	$V_{CC} - 0.1$	V_{CC}		$V_{CC} - 0.1$		V
		$I_{OH} = -3\ \text{mA}$	1.65	1.29	1.52		1.29		
		$I_{OH} = -8\ \text{mA}$	2.3	1.9	2.1		1.9		
		$I_{OH} = -12\ \text{mA}$	2.7	2.2	2.4		2.2		
		$I_{OH} = -16\ \text{mA}$	3.0	2.4	2.7		2.4		
		$I_{OH} = -24\ \text{mA}$	3.0	2.3	2.5		2.3		
		$I_{OH} = -32\ \text{mA}$	4.5	3.8	4.0		3.8		
V_{OL}	Low-Level Output Voltage $V_{IN} = V_{IH}$	$I_{OL} = 100\ \mu\text{A}$	1.65 to 5.5		0.0	0.1		0.1	V
		$I_{OH} = 3\ \text{mA}$	1.65		0.08	0.24		0.24	
		$I_{OL} = 8\ \text{mA}$	2.3		0.20	0.3		0.3	
		$I_{OL} = 12\ \text{mA}$	2.7		0.22	0.4		0.4	
		$I_{OL} = 16\ \text{mA}$	3.0		0.28	0.4		0.4	
		$I_{OL} = 24\ \text{mA}$	3.0		0.38	0.55		0.55	
		$I_{OL} = 32\ \text{mA}$	4.5		0.42	0.55		0.55	
I_{IN}	Input Leakage Current	$V_{IN} = 5.5\ \text{V}$ or GND	0 to 5.5		± 0.1			± 1.0	μA
I_{OFF}	Power Off Leakage Current	$V_{IN} = 5.5\ \text{V}$ or $V_{OUT} = 5.5\ \text{V}$	0			1		10	μA
I_{CC}	Quiescent Supply Current	$V_{IN} = 5.5\ \text{V}$ or GND	5.5			1		10	μA

Product parametric performance is indicated in the Electrical Characteristics for the listed test conditions, unless otherwise noted. Product performance may not be indicated by the Electrical Characteristics if operated under different conditions.

NLV17SZ04

AC ELECTRICAL CHARACTERISTICS $t_R = t_F = 2.5 \text{ ns}$; $C_L = 50 \text{ pF}$; $R_L = 500 \Omega$

Symbol	Parameter	Condition	V_{CC} (V)	$T_A = 25^\circ\text{C}$			$-55^\circ\text{C} \leq T_A \leq 125^\circ\text{C}$		Unit
				Min	Typ	Max	Min	Max	
t_{PLH} t_{PHL}	Propagation Delay (Figure 3 and 4)	$R_L = 1 \text{ M}\Omega$, $C_L = 15 \text{ pF}$	1.65	2.0	5.3	11.4	2.0	12.0	ns
			1.8	2.0	4.4	9.5	2.0	10.0	
		$R_L = 1 \text{ M}\Omega$, $C_L = 15 \text{ pF}$	2.5 ± 0.2	0.2	3.5	6.5	0.8	7.0	
			3.3 ± 0.3	0.8	2.1	4.5	0.5	4.7	
		$R_L = 500 \Omega$, $C_L = 50 \text{ pF}$		1.2	2.9	5.5	1.5	5.2	
		$R_L = 1 \text{ M}\Omega$, $C_L = 15 \text{ pF}$	5.0 ± 0.5	0.5	1.8	3.9	0.5	4.1	
$R_L = 500 \Omega$, $C_L = 50 \text{ pF}$		0.8	2.4	4.3	0.8	4.5			

CAPACITIVE CHARACTERISTICS

Symbol	Parameter	Condition	Typical	Unit
C_{IN}	Input Capacitance	$V_{CC} = 5.5 \text{ V}$, $V_I = 0 \text{ V}$ or V_{CC}	> 2.5	pF
C_{PD}	Power Dissipation Capacitance (Note 7)	10 MHz, $V_{CC} = 3.3 \text{ V}$, $V_I = 0 \text{ V}$ or V_{CC} 10 MHz, $V_{CC} = 5.5 \text{ V}$, $V_I = 0 \text{ V}$ or V_{CC}	9 11	pF

7. C_{PD} is defined as the value of the internal equivalent capacitance which is calculated from the operating current consumption without load. Average operating current can be obtained by the equation: $I_{CC(OPR)} = C_{PD} \cdot V_{CC} \cdot f_{in} + I_{CC}$. C_{PD} is used to determine the no-load dynamic power consumption; $P_D = C_{PD} \cdot V_{CC}^2 \cdot f_{in} + I_{CC} \cdot V_{CC}$.

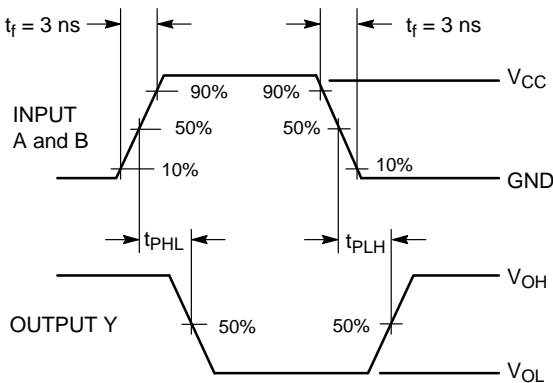

Figure 3. Switching Waveform

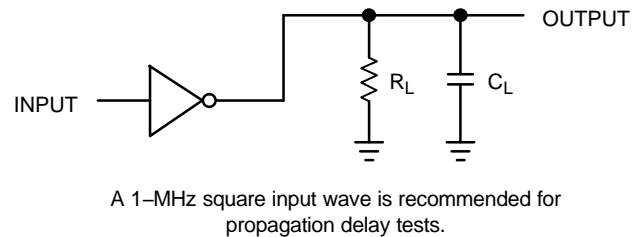

Figure 4. Test Circuit

ORDERING INFORMATION

Device	Package	Shipping†
NLV17SZ04DFT2G*	SC-88A/SOT-353/SC-70-5 (Pb-Free)	3000 / Tape & Reel

†For information on tape and reel specifications, including part orientation and tape sizes, please refer to our Tape and Reel Packaging Specifications Brochure, BRD8011/D.

*NLV Prefix for Automotive and Other Applications Requiring Unique Site and Control Change Requirements; AEC-Q100 Qualified and PPAP Capable.

NLV17SZ04

PACKAGE DIMENSIONS

SC-88A (SC-70-5/SOT-353) CASE 419A-02 ISSUE L

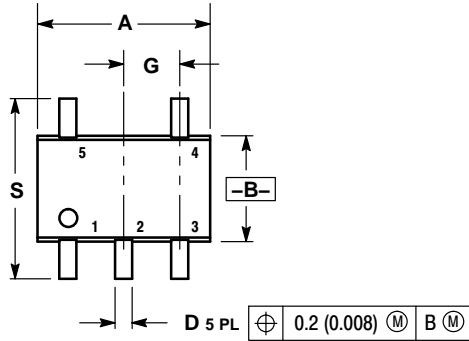

NOTES:

1. DIMENSIONING AND TOLERANCING PER ANSI Y14.5M, 1982.
2. CONTROLLING DIMENSION: INCH.
3. 419A-01 OBSOLETE. NEW STANDARD 419A-02.
4. DIMENSIONS A AND B DO NOT INCLUDE MOLD FLASH, PROTRUSIONS, OR GATE BURRS.

DIM	INCHES		MILLIMETERS	
	MIN	MAX	MIN	MAX
A	0.071	0.087	1.80	2.20
B	0.045	0.053	1.15	1.35
C	0.031	0.043	0.80	1.10
D	0.004	0.012	0.10	0.30
G	0.026 BSC		0.65 BSC	
H	---	0.004	---	0.10
J	0.004	0.010	0.10	0.25
K	0.004	0.012	0.10	0.30
N	0.008 REF		0.20 REF	
S	0.079	0.087	2.00	2.20

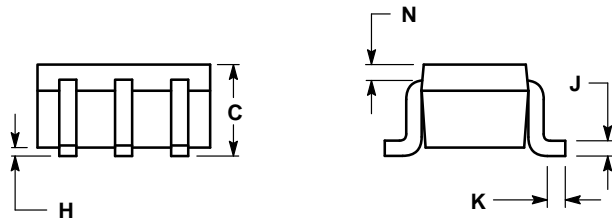

SOLDER FOOTPRINT*

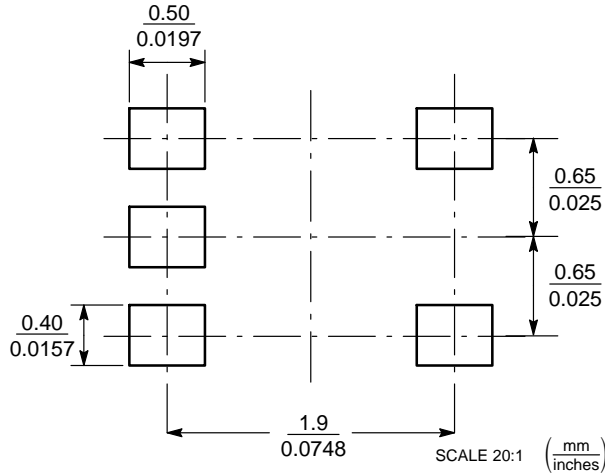

*For additional information on our Pb-Free strategy and soldering details, please download the ON Semiconductor Soldering and Mounting Techniques Reference Manual, SOLDERRM/D.

ON Semiconductor and the  are registered trademarks of Semiconductor Components Industries, LLC (SCILLC) or its subsidiaries in the United States and/or other countries. SCILLC owns the rights to a number of patents, trademarks, copyrights, trade secrets, and other intellectual property. A listing of SCILLC's product/patent coverage may be accessed at www.onsemi.com/site/pdf/Patent-Marking.pdf. SCILLC reserves the right to make changes without further notice to any products herein. SCILLC makes no warranty, representation or guarantee regarding the suitability of its products for any particular purpose, nor does SCILLC assume any liability arising out of the application or use of any product or circuit, and specifically disclaims any and all liability, including without limitation special, consequential or incidental damages. "Typical" parameters which may be provided in SCILLC data sheets and/or specifications can and do vary in different applications and actual performance may vary over time. All operating parameters, including "Typicals" must be validated for each customer application by customer's technical experts. SCILLC does not convey any license under its patent rights nor the rights of others. SCILLC products are not designed, intended, or authorized for use as components in systems intended for surgical implant into the body, or other applications intended to support or sustain life, or for any other application in which the failure of the SCILLC product could create a situation where personal injury or death may occur. Should Buyer purchase or use SCILLC products for any such unintended or unauthorized application, Buyer shall indemnify and hold SCILLC and its officers, employees, subsidiaries, affiliates, and distributors harmless against all claims, costs, damages, and expenses, and reasonable attorney fees arising out of, directly or indirectly, any claim of personal injury or death associated with such unintended or unauthorized use, even if such claim alleges that SCILLC was negligent regarding the design or manufacture of the part. SCILLC is an Equal Opportunity/Affirmative Action Employer. This literature is subject to all applicable copyright laws and is not for resale in any manner.

PUBLICATION ORDERING INFORMATION

LITERATURE FULFILLMENT:
Literature Distribution Center for ON Semiconductor
19521 E. 32nd Pkwy, Aurora, Colorado 80011 USA
Phone: 303-675-2175 or 800-344-3860 Toll Free USA/Canada
Fax: 303-675-2176 or 800-344-3867 Toll Free USA/Canada
Email: orderlit@onsemi.com

N. American Technical Support: 800-282-9855 Toll Free
USA/Canada
Europe, Middle East and Africa Technical Support:
Phone: 421 33 790 2910
Japan Customer Focus Center
Phone: 81-3-5817-1050

ON Semiconductor Website: www.onsemi.com
Order Literature: <http://www.onsemi.com/orderlit>
For additional information, please contact your local Sales Representative