



Is Now Part of



ON Semiconductor®

To learn more about ON Semiconductor, please visit our website at
www.onsemi.com

Please note: As part of the Fairchild Semiconductor integration, some of the Fairchild orderable part numbers will need to change in order to meet ON Semiconductor's system requirements. Since the ON Semiconductor product management systems do not have the ability to manage part nomenclature that utilizes an underscore (_), the underscore (_) in the Fairchild part numbers will be changed to a dash (-). This document may contain device numbers with an underscore (_). Please check the ON Semiconductor website to verify the updated device numbers. The most current and up-to-date ordering information can be found at www.onsemi.com. Please email any questions regarding the system integration to Fairchild_questions@onsemi.com.

ON Semiconductor and the ON Semiconductor logo are trademarks of Semiconductor Components Industries, LLC dba ON Semiconductor or its subsidiaries in the United States and/or other countries. ON Semiconductor owns the rights to a number of patents, trademarks, copyrights, trade secrets, and other intellectual property. A listing of ON Semiconductor's product/patent coverage may be accessed at www.onsemi.com/site/pdf/Patent-Marking.pdf. ON Semiconductor reserves the right to make changes without further notice to any products herein. ON Semiconductor makes no warranty, representation or guarantee regarding the suitability of its products for any particular purpose, nor does ON Semiconductor assume any liability arising out of the application or use of any product or circuit, and specifically disclaims any and all liability, including without limitation special, consequential or incidental damages. Buyer is responsible for its products and applications using ON Semiconductor products, including compliance with all laws, regulations and safety requirements or standards, regardless of any support or applications information provided by ON Semiconductor. "Typical" parameters which may be provided in ON Semiconductor data sheets and/or specifications can and do vary in different applications and actual performance may vary over time. All operating parameters, including "Typicals" must be validated for each customer application by customer's technical experts. ON Semiconductor does not convey any license under its patent rights nor the rights of others. ON Semiconductor products are not designed, intended, or authorized for use as a critical component in life support systems or any FDA Class 3 medical devices or medical devices with a same or similar classification in a foreign jurisdiction or any devices intended for implantation in the human body. Should Buyer purchase or use ON Semiconductor products for any such unintended or unauthorized application, Buyer shall indemnify and hold ON Semiconductor and its officers, employees, subsidiaries, affiliates, and distributors harmless against all claims, costs, damages, and expenses, and reasonable attorney fees arising out of, directly or indirectly, any claim of personal injury or death associated with such unintended or unauthorized use, even if such claim alleges that ON Semiconductor was negligent regarding the design or manufacture of the part. ON Semiconductor is an Equal Opportunity/Affirmative Action Employer. This literature is subject to all applicable copyright laws and is not for resale in any manner.

NC7SPU04 TinyLogic® ULP Unbuffered Inverter

General Description

The NC7SPU04 is a single unbuffered inverter from Fairchild's Ultra Low Power (ULP) series of TinyLogic®. Ideal for applications where battery life is critical, this product is designed for ultra low power consumption within the V_{CC} operating range of 0.9V to 3.6V V_{CC} .

The internal circuit is composed of a minimum of inverter stages, including the output buffer, to enable ultra low static and dynamic power.

The NC7SPU04, for lower drive requirements, is uniquely designed for optimized power and speed, and is fabricated with an advanced CMOS technology to achieve best in class speed operation while maintaining extremely low CMOS power dissipation.

Features

- 0.9V to 3.6V V_{CC} supply operation
- 3.6V overvoltage tolerant I/O's at V_{CC} from 0.9V to 3.6V
- t_{PD}
 - 4.0 ns typ for 3.0V to 3.6V V_{CC}
 - 5.0 ns typ for 2.3V to 2.7V V_{CC}
 - 6.0 ns typ for 1.65V to 1.95V V_{CC}
 - 7.0 ns typ for 1.40V to 1.60V V_{CC}
 - 11.0 ns typ for 1.10V to 1.30V V_{CC}
 - 27.0 ns typ for 0.90V V_{CC}
- Power-Off high impedance inputs and outputs
- Static Drive (I_{OH}/I_{OL})
 - ±2.6 mA @ 3.00V V_{CC}
 - ±2.1 mA @ 2.30V V_{CC}
 - ±1.5 mA @ 1.65V V_{CC}
 - ±1.0 mA @ 1.40V V_{CC}
 - ±0.5 mA @ 1.10V V_{CC}
 - ±10 μ A @ 0.9V V_{CC}
- Uses proprietary Quiet Series™ noise/EMI reduction circuitry
- Ultra small MicroPak™ leadfree package
- Ultra Low dynamic power

Ordering Code:

| Order Number | Package Number | Product Code Top Mark | Package Description | Supplied As |
|--------------|----------------|-----------------------|---------------------------------------|---------------------------|
| NC7SPU04P5X | MAA05A | PU4 | 5-Lead SC70, EIAJ SC-88a, 1.25mm Wide | 3k Units on Tape and Reel |
| NC7SPU04L6X | MAC06A | N3 | 6-Lead MicroPak, 1.0mm Wide | 5k Units on Tape and Reel |

Battery Life vs. V_{CC} Supply Voltage

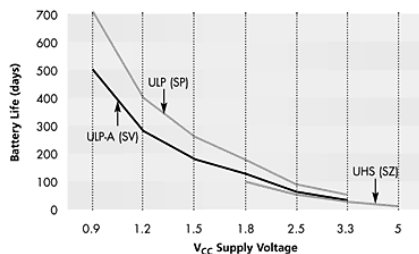

TinyLogic ULP and ULP-A with up to 50% less power consumption can extend your battery life significantly.

$$\text{Battery Life} = (V_{\text{battery}} \cdot I_{\text{battery}} \cdot 9) / (P_{\text{device}}) / 24 \text{hrs/day}$$

$$\text{Where, } P_{\text{device}} = (I_{CC} \cdot V_{CC}) + (C_{PD} + C_L) \cdot V_{CC}^2 \cdot f$$

Assumes ideal 3.6V Lithium Ion battery with current rating of 900mAh and derated 90% and device frequency at 10MHz, with $C_L = 15$ pF load

TinyLogic®, Quiet Series™, and MicroPak™ are trademarks of Fairchild Semiconductor Corporation.

Logic Symbol

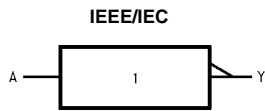

Pin Descriptions

| Pin Names | Description |
|-----------|-------------|
| A | Input |
| Y | Output |
| NC | No Connect |

Function Table

$$Y = \bar{A}$$

| Input | Output |
|-------|--------|
| A | Y |
| L | H |
| H | L |

H = HIGH Logic Level
L = LOW Logic Level

Connection Diagrams

Pin Assignments for SC70

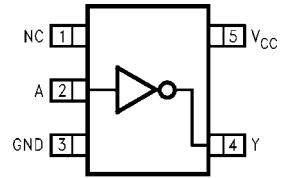

(Top View)

Pad Assignments for MicroPak

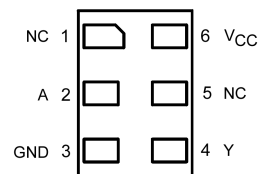

(Top Thru View)

| Absolute Maximum Ratings (Note 1) | | Recommended Operating Conditions (Note 3) | |
|---|-------------------------|---|----------------|
| Supply Voltage (V_{CC}) | -0.5V to +4.6V | Supply Voltage | 0.9V to 3.6V |
| DC Input Voltage (V_{IN}) | -0.5V to +4.6V | Input Voltage (V_{IN}) | 0V to 3.6V |
| DC Output Voltage (V_{OUT}) | | Output Voltage (V_{OUT}) | |
| HIGH or LOW State (Note 2) | -0.5V to V_{CC} +0.5V | HIGH or LOW State | 0V to V_{CC} |
| $V_{CC} = 0V$ | -0.5V to 4.6V | $V_{CC} = 0V$ | 0V to 3.6V |
| DC Input Diode Current (I_{IK}) $V_{IN} < 0V$ | ±50 mA | Output Current in I_{OH}/I_{OL} | |
| DC Output Diode Current (I_{OK}) | | $V_{CC} = 3.0V$ to 3.6V | ±2.6 mA |
| $V_{OUT} > 0V$ | -50 mA | $V_{CC} = 2.3V$ to 2.7V | ±2.1 mA |
| $V_{OUT} < V_{CC}$ | +50 mA | $V_{CC} = 1.65V$ to 1.95V | ±1.5 mA |
| DC Output Source/Sink Current (I_{OH}/I_{OL}) | ± 50 mA | $V_{CC} = 1.40V$ to 1.60V | ± 1 mA |
| DC V_{CC} or Ground Current per | | $V_{CC} = 1.10V$ to 1.30V | ±0.5 mA |
| Supply Pin (I_{CC} or Ground) | ± 50 mA | $V_{CC} = 0.9V$ | ±20 μA |
| Storage Temperature Range (T_{STG}) | -65°C to +150°C | Free Air Operating Temperature (T_A) | -40°C to +85°C |
| | | Minimum Input Edge Rate ($\Delta t/\Delta V$) | |
| | | $V_{IN} = 0.8V$ to 2.0V, $V_{CC} = 3.0V$ | 10 ns/V |

Note 1: Absolute Maximum Ratings: are those values beyond which the safety of the device cannot be guaranteed. The device should not be operated at these limits. The parametric values defined in the Electrical Characteristics tables are not guaranteed at the absolute maximum ratings. The "Recommended Operating Conditions" table will define the conditions for actual device operation.

Note 2: I_O Absolute Maximum Rating must be observed.

Note 3: Unused inputs must be held HIGH or LOW. They may not float.

DC Electrical Characteristics

| Symbol | Parameter | V_{CC} (V) | $T_A = +25^\circ C$ | | $T_A = -40^\circ C$ to $+85^\circ C$ | | Units | Conditions |
|----------|------------------------------|------------------------------|---------------------|----------------|--------------------------------------|--------------------|-------|----------------------|
| | | | Min | Max | Min | Max | | |
| V_{IH} | HIGH Level Input Voltage | 0.90 | 0.8 x V_{CC} | | 0.8 x V_{CC} | | V | |
| | | $1.10 \leq V_{CC} \leq 1.30$ | 0.8 x V_{CC} | | 0.8 x V_{CC} | | | |
| | | $1.40 \leq V_{CC} \leq 1.60$ | 0.8 x V_{CC} | | 0.8 x V_{CC} | | | |
| | | $1.65 \leq V_{CC} \leq 1.95$ | 0.8 x V_{CC} | | 0.8 x V_{CC} | | | |
| | | $2.30 \leq V_{CC} \leq 2.70$ | 0.8 x V_{CC} | | 0.8 x V_{CC} | | | |
| | | $3.00 \leq V_{CC} \leq 3.60$ | 0.8 x V_{CC} | | 0.8 x V_{CC} | | | |
| V_{IL} | LOW Level Input Voltage | 0.90 | | 0.2 x V_{CC} | | 0.2 x V_{CC} | V | |
| | | $1.10 \leq V_{CC} \leq 1.30$ | | 0.2 x V_{CC} | | 0.2 x V_{CC} | | |
| | | $1.40 \leq V_{CC} \leq 1.60$ | | 0.2 x V_{CC} | | 0.2 x V_{CC} | | |
| | | $1.65 \leq V_{CC} \leq 1.95$ | | 0.2 x V_{CC} | | 0.2 x V_{CC} | | |
| | | $2.30 \leq V_{CC} \leq 2.70$ | | 0.2 x V_{CC} | | 0.2 x V_{CC} | | |
| | | $3.00 \leq V_{CC} \leq 3.60$ | | 0.2 x V_{CC} | 0.2 x V_{CC} | | | |
| V_{OH} | HIGH Level Output Voltage | 0.90 | $V_{CC} - 0.2$ | | $V_{CC} - 0.2$ | | V | $I_{OH} = -10 \mu A$ |
| | | $1.10 \leq V_{CC} \leq 1.30$ | $V_{CC} - 0.2$ | | $V_{CC} - 0.2$ | | | $I_{OH} = -20 \mu A$ |
| | | $1.40 \leq V_{CC} \leq 1.60$ | $V_{CC} - 0.2$ | | $V_{CC} - 0.2$ | | | |
| | | $1.65 \leq V_{CC} \leq 1.95$ | $V_{CC} - 0.2$ | | $V_{CC} - 0.2$ | | | |
| | | $2.30 \leq V_{CC} \leq 2.70$ | $V_{CC} - 0.2$ | | $V_{CC} - 0.2$ | | | |
| | | $3.00 \leq V_{CC} \leq 3.60$ | $V_{CC} - 0.2$ | | $V_{CC} - 0.2$ | | | |
| | | $1.10 \leq V_{CC} \leq 1.30$ | 0.75 x V_{CC} | | 0.70 x V_{CC} | | | $I_{OH} = -0.5 mA$ |
| | | $1.40 \leq V_{CC} \leq 1.60$ | 1.07 | | 0.99 | | | $I_{OH} = -1 mA$ |
| | | $1.65 \leq V_{CC} \leq 1.95$ | 1.24 | | 1.22 | | | $I_{OH} = -1.5 mA$ |
| | | $2.30 \leq V_{CC} \leq 2.70$ | 1.95 | | 1.87 | | | $I_{OH} = -2.1 mA$ |
| | $3.00 \leq V_{CC} \leq 3.60$ | 2.61 | | 2.55 | | $I_{OH} = -2.6 mA$ | | |

| DC Electrical Characteristics (Continued) | | | | | | | | | | |
|---|-------------------------------|-------------------------------|------------------------|------------------------|---------------------------------|---------------------------------|-------|--|---|--------------------------|
| Symbol | Parameter | V _{CC} (V) | T _A = +25°C | | T _A = -40°C to +85°C | | Units | Conditions | | |
| | | | Min | Max | Min | Max | | | | |
| V _{OL} | LOW Level | 0.90 | | 0.1 | | 0.1 | V | | I _{OL} = 10 μA | |
| | Output Voltage | 1.10 ≤ V _{CC} ≤ 1.30 | | 0.1 | | 0.1 | | | I _{OL} = 20 μA | |
| | | 1.40 ≤ V _{CC} ≤ 1.60 | | 0.1 | | 0.1 | | | | |
| | | 1.65 ≤ V _{CC} ≤ 1.95 | | 0.1 | | 0.1 | | | | |
| | | 2.30 ≤ V _{CC} ≤ 2.70 | | 0.1 | | 0.1 | | | | |
| | | 3.00 ≤ V _{CC} ≤ 3.60 | | 0.1 | | 0.1 | | | | |
| | | 1.10 ≤ V _{CC} ≤ 1.30 | | 0.30 × V _{CC} | | 0.30 × V _{CC} | | | | I _{OL} = 0.5 mA |
| | | 1.40 ≤ V _{CC} ≤ 1.60 | | 0.31 | | 0.37 | | | | I _{OL} = 1 mA |
| | | 1.65 ≤ V _{CC} ≤ 1.95 | | 0.31 | | 0.35 | | | | I _{OL} = 1.5 mA |
| | 2.30 ≤ V _{CC} ≤ 2.70 | | 0.31 | | 0.33 | I _{OL} = 2.1 mA | | | | |
| 3.00 ≤ V _{CC} ≤ 3.60 | | 0.31 | | 0.33 | I _{OL} = 2.6 mA | | | | | |
| I _{IN} | Input Leakage Current | 0.90 to 3.60 | | ±0.1 | | ±0.5 | μA | 0 ≤ V _I ≤ 3.6V | | |
| I _{CC} | Quiescent Supply Current | 0.90 to 3.60 | | 0.9 | | 0.9 | μA | V _I = V _{CC} or GND | | |
| AC Electrical Characteristics | | | | | | | | | | |
| Symbol | Parameter | V _{CC} (V) | T _A = +25°C | | | T _A = -40°C to +85°C | | Units | Conditions | Figure Number |
| | | | Min | Typ | Max | Min | Max | | | |
| t _{PHL} t _{PLH} | Propagation Delay | 0.90 | | 27 | | | | ns | C _L = 10 pF R _L = 1 MΩ | Figures 1, 2 |
| | | 1.10 ≤ V _{CC} ≤ 1.30 | 3.5 | 11 | 21.8 | 3.0 | 34.3 | | | |
| | | 1.40 ≤ V _{CC} ≤ 1.60 | 2.5 | 7 | 14.8 | 2.0 | 15.0 | | | |
| | | 1.65 ≤ V _{CC} ≤ 1.95 | 2.0 | 6 | 12.0 | 1.5 | 12.2 | | | |
| | | 2.30 ≤ V _{CC} ≤ 2.70 | 1.5 | 5 | 9.4 | 1.0 | 9.9 | | | |
| 3.00 ≤ V _{CC} ≤ 3.60 | 1.0 | 4 | 8.3 | 1.0 | 9.0 | | | | | |
| t _{PHL} t _{PLH} | Propagation Delay | 0.90 | | 30 | | | | ns | C _L = 15 pF R _L = 1 MΩ | Figures 1, 2 |
| | | 1.10 ≤ V _{CC} ≤ 1.30 | 4.0 | 11 | 22.8 | 3.5 | 37.3 | | | |
| | | 1.40 ≤ V _{CC} ≤ 1.60 | 3.0 | 8 | 15.5 | 2.5 | 16.5 | | | |
| | | 1.65 ≤ V _{CC} ≤ 1.95 | 2.5 | 6 | 12.6 | 2.0 | 13.6 | | | |
| | | 2.30 ≤ V _{CC} ≤ 2.70 | 2.0 | 5 | 9.9 | 1.5 | 10.8 | | | |
| 3.00 ≤ V _{CC} ≤ 3.60 | 1.5 | 4 | 8.7 | 1.0 | 9.5 | | | | | |
| t _{PHL} t _{PLH} | Propagation Delay | 0.90 | | 32 | | | | ns | C _L = 30 pF R _L = 1 MΩ | Figures 1, 2 |
| | | 1.10 ≤ V _{CC} ≤ 1.30 | 5.0 | 13 | 25.9 | 4.0 | 46.3 | | | |
| | | 1.40 ≤ V _{CC} ≤ 1.60 | 4.0 | 9 | 17.8 | 3.5 | 18.2 | | | |
| | | 1.65 ≤ V _{CC} ≤ 1.95 | 3.0 | 7 | 14.4 | 2.0 | 15.9 | | | |
| | | 2.30 ≤ V _{CC} ≤ 2.70 | 2.0 | 6 | 11.3 | 1.5 | 12.8 | | | |
| 3.00 ≤ V _{CC} ≤ 3.60 | 1.5 | 5 | 9.2 | 1.0 | 10.7 | | | | | |
| C _{IN} | Input Capacitance | 0 | | 2.0 | | | pF | | | |
| C _{OUT} | Output Capacitance | 0 | | 4.0 | | | pF | | | |
| C _{PD} | Power Dissipation Capacitance | 0.9 to 3.60 | | 8 | | | pF | V _I = 0V or V _{CC} , f = 10 MHz | | |

AC Loading and Waveforms

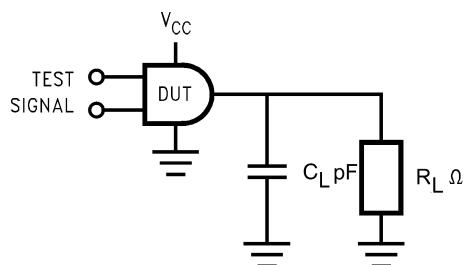

FIGURE 1. AC Test Circuit

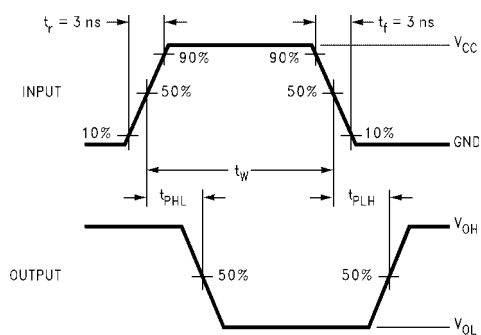

FIGURE 2. AC Waveforms

| Symbol | V_{CC} | | | | | |
|----------|-----------------|-----------------|------------------|------------------|------------------|------------|
| | $3.3V \pm 0.3V$ | $2.5V \pm 0.2V$ | $1.8V \pm 0.15V$ | $1.5V \pm 0.10V$ | $1.2V \pm 0.10V$ | $0.9V$ |
| V_{mi} | 1.5V | $V_{CC}/2$ | $V_{CC}/2$ | $V_{CC}/2$ | $V_{CC}/2$ | $V_{CC}/2$ |
| V_{mo} | 1.5V | $V_{CC}/2$ | $V_{CC}/2$ | $V_{CC}/2$ | $V_{CC}/2$ | $V_{CC}/2$ |

Tape and Reel Specification

TAPE FORMAT for SC70

| Package Designator | Tape Section | Number Cavities | Cavity Status | Cover Tape Status |
|--------------------|--------------------|-----------------|---------------|-------------------|
| P5X | Leader (Start End) | 125 (typ) | Empty | Sealed |
| | Carrier | 3000 | Filled | Sealed |
| | Trailer (Hub End) | 75 (typ) | Empty | Sealed |

TAPE DIMENSIONS inches (millimeters)

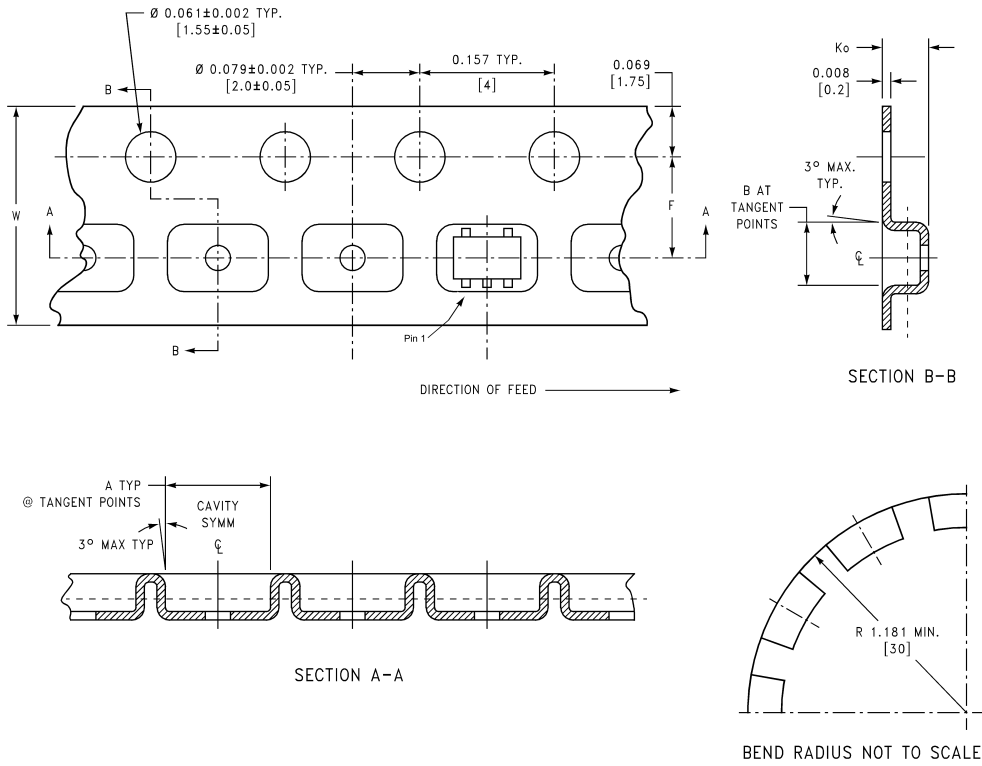

Tape and Reel Specification (Continued)

TAPE FORMAT for MicroPak

| Package Designator | Tape Section | Number Cavities | Cavity Status | Cover Tape Status |
|--------------------|--------------------|-----------------|---------------|-------------------|
| L6X | Leader (Start End) | 125 (typ) | Empty | Sealed |
| | Carrier | 5000 | Filled | Sealed |
| | Trailer (Hub End) | 75 (typ) | Empty | Sealed |

TAPE DIMENSIONS inches (millimeters)



REEL DIMENSIONS inches (millimeters)

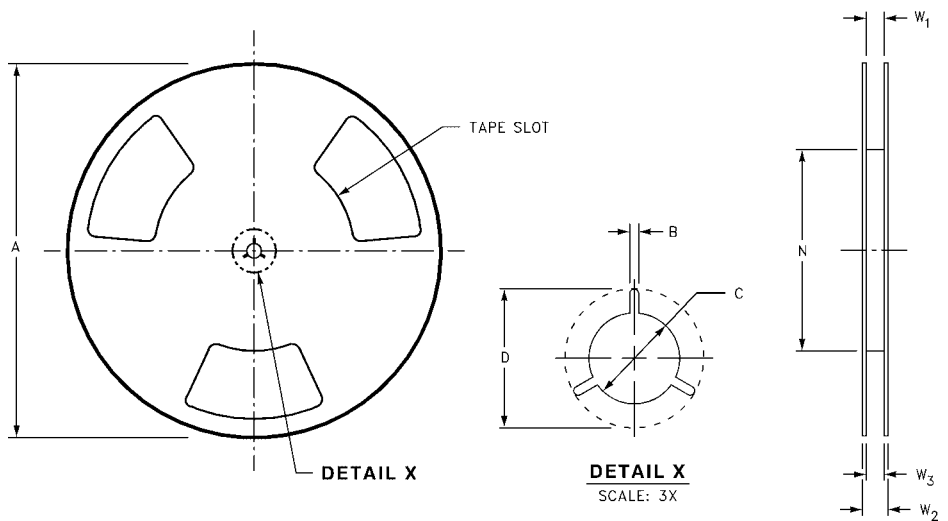

| Tape Size | A | B | C | D | N | W1 | W2 | W3 |
|-----------|----------------|-----------------|------------------|------------------|------------------|---|------------------|--|
| 8 mm | 7.0 (177.8) | 0.059 (1.50) | 0.512 (13.00) | 0.795 (20.20) | 2.165 (55.00) | 0.331 + 0.059/-0.000 (8.40 + 1.50/-0.00) | 0.567 (14.40) | W1 + 0.078/-0.039 (W1 + 2.00/-1.00) |

Physical Dimensions inches (millimeters) unless otherwise noted



NOTES:

- A. CONFORMS TO EIAJ REGISTERED OUTLINE DRAWING SC88A.
- B. DIMENSIONS DO NOT INCLUDE BURRS OR MOLD FLASH.
- C. DIMENSIONS ARE IN MILLIMETERS.

MAA05ARevC

**5-Lead SC70, EIAJ SC-88a, 1.25mm Wide
Package Number MAA05A**

Physical Dimensions inches (millimeters) unless otherwise noted (Continued)



- Notes:
1. JEDEC PACKAGE REGISTRATION IS ANTICIPATED
 2. DIMENSIONS ARE IN MILLIMETERS
 3. DRAWING CONFORMS TO ASME Y14.5M-1994

MAC06ARevB

**6-Lead MicroPak, 1.0mm Wide
Package Number MAC06A**

Fairchild does not assume any responsibility for use of any circuitry described, no circuit patent licenses are implied and Fairchild reserves the right at any time without notice to change said circuitry and specifications.

LIFE SUPPORT POLICY

FAIRCHILD'S PRODUCTS ARE NOT AUTHORIZED FOR USE AS CRITICAL COMPONENTS IN LIFE SUPPORT DEVICES OR SYSTEMS WITHOUT THE EXPRESS WRITTEN APPROVAL OF THE PRESIDENT OF FAIRCHILD SEMICONDUCTOR CORPORATION. As used herein:

1. Life support devices or systems are devices or systems which, (a) are intended for surgical implant into the body, or (b) support or sustain life, and (c) whose failure to perform when properly used in accordance with instructions for use provided in the labeling, can be reasonably expected to result in a significant injury to the user.
2. A critical component in any component of a life support device or system whose failure to perform can be reasonably expected to cause the failure of the life support device or system, or to affect its safety or effectiveness.

www.fairchildsemi.com

ON Semiconductor and  are trademarks of Semiconductor Components Industries, LLC dba ON Semiconductor or its subsidiaries in the United States and/or other countries. ON Semiconductor owns the rights to a number of patents, trademarks, copyrights, trade secrets, and other intellectual property. A listing of ON Semiconductor's product/patent coverage may be accessed at www.onsemi.com/site/pdf/Patent-Marking.pdf. ON Semiconductor reserves the right to make changes without further notice to any products herein. ON Semiconductor makes no warranty, representation or guarantee regarding the suitability of its products for any particular purpose, nor does ON Semiconductor assume any liability arising out of the application or use of any product or circuit, and specifically disclaims any and all liability, including without limitation special, consequential or incidental damages. Buyer is responsible for its products and applications using ON Semiconductor products, including compliance with all laws, regulations and safety requirements or standards, regardless of any support or applications information provided by ON Semiconductor. "Typical" parameters which may be provided in ON Semiconductor data sheets and/or specifications can and do vary in different applications and actual performance may vary over time. All operating parameters, including "Typicals" must be validated for each customer application by customer's technical experts. ON Semiconductor does not convey any license under its patent rights nor the rights of others. ON Semiconductor products are not designed, intended, or authorized for use as a critical component in life support systems or any FDA Class 3 medical devices or medical devices with a same or similar classification in a foreign jurisdiction or any devices intended for implantation in the human body. Should Buyer purchase or use ON Semiconductor products for any such unintended or unauthorized application, Buyer shall indemnify and hold ON Semiconductor and its officers, employees, subsidiaries, affiliates, and distributors harmless against all claims, costs, damages, and expenses, and reasonable attorney fees arising out of, directly or indirectly, any claim of personal injury or death associated with such unintended or unauthorized use, even if such claim alleges that ON Semiconductor was negligent regarding the design or manufacture of the part. ON Semiconductor is an Equal Opportunity/Affirmative Action Employer. This literature is subject to all applicable copyright laws and is not for resale in any manner.

PUBLICATION ORDERING INFORMATION

LITERATURE FULFILLMENT:

Literature Distribution Center for ON Semiconductor
19521 E. 32nd Pkwy, Aurora, Colorado 80011 USA
Phone: 303-675-2175 or 800-344-3860 Toll Free USA/Canada
Fax: 303-675-2176 or 800-344-3867 Toll Free USA/Canada
Email: orderlit@onsemi.com

N. American Technical Support: 800-282-9855 Toll Free
USA/Canada
Europe, Middle East and Africa Technical Support:
Phone: 421 33 790 2910
Japan Customer Focus Center
Phone: 81-3-5817-1050

ON Semiconductor Website: www.onsemi.com
Order Literature: <http://www.onsemi.com/orderlit>
For additional information, please contact your local
Sales Representative