

8 Series Toggle Switches

■ Introduction

The **8 Series Toggles** is Copal Electronics' high-reliability miniature switch product offering. This product line meets and exceeds all basic international switch standards.

With **8** toggle options, PC and solder lug terminals, power and logic level current ratings, 1-4 pole and many circuit offerings these switches can be used in many industries and various applications within these industries.

Four of the **8 Series** lines are washable. Specifically designed for PC applications with automated solder and cleaning methods.

The **8 Series** is available with **UL** Recognition and **CSA** Certification upon request from the customer.

■ Applications





































- Communication equipment
- Computer peripheral equipment
- Measuring instruments
- Medical equipment
- Automotive diagnosis

The switches can be used in a wide range of fields from industrial to consumer equipment.

■ Features of 8 Series Toggles

- 1. Terminal style :**
Solder, Straight, Right angle and vertical mount PC terminals.
- 2. Contacts :**
Silver or gold.
- 3. Epoxy resin case :**
UL94V-0 self-extinguishing epoxy.
- 4. Actuator styles :**
Over 30 actuator variations.
- 5. Insulation between terminal and ground :**
4 mm minimum.
- 6. Prevention of flux entry**
The epoxy resin seal on bottom of the switch helps prevent the entry of solder and flux.
- 7. Insulation barrier :**
Insulation barrier design between poles helps prevent short-circuiting between poles ensuring high reliability.
- 8. UL Recognized product File No.E43275**
- 9. CSA Certified product File No.LR38341**
- 10. For the UL Recognized and CSA Certified products please see page 412.**

8 Series Toggles Selection Table

Part No.	Name	Actuator shape	Number of poles	Switching function	Terminals	Page	
8A	Standard toggle		1·2·3·4	ON — ON ON — OFF — ON (ON) — OFF — (ON) ON — OFF — (ON) ON — — (ON) ※1/2 Poles ON — ON ON — OFF — ON ※3/4 Poles ON — ON — ON ON — ON — (ON) (ON) — ON — (ON) ※8A Type 2&4 Poles only	  Solder Lug Straight PC	389 } 391	
8B	Mustang Toggle		1·2·3·4		  Solder Lug Straight PC	392 } 393	
8C	Flatted Toggle		1·2·3·4		  Solder Lug Straight PC	394 } 395	
8D	Long Toggle		1·2·3·4		  Solder Lug Straight PC	396 } 397	
8E	Lever Lock Toggle		1·2·3·4		  Solder Lug Straight PC	398 } 399	
8F	Splash Proof Toggle		1·2·3·4		  Solder Lug Straight PC	400 } 401	
8J	Short Toggle		1·2·3·4		  Solder Lug Straight PC	402 } 403	
8S	Color Tip Toggle		1·2·3·4		  Solder Lug Straight PC	404 } 405	
Washable	8G	Short Toggle Washable	1·2		ON — ON ON — OFF — ON (ON) — OFF — (ON) ON — OFF — (ON) ON — — (ON)	   Straight PC Right Angle Vertical	406 } 407
	8GA	Standard Toggle Washable	1·2			   Straight PC Right Angle Vertical	408
	8GD	Long Toggle Washable	1·2	   Straight PC Right Angle Vertical		409	
	8GS	Color Tip Toggle Washable	1·2	   Straight PC Right Angle Vertical		410	

() indicates momentary actuation

■ Terminals

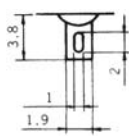
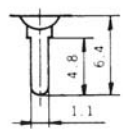
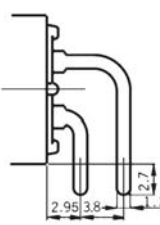
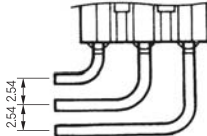
Solder Terminal (Style:1)	PC Straight (Style:2)	Right Angle (Style:4)	Vertical Mount (Style:6)
t=0.8 	t=0.8 PC 	t=0.8 R/A 	t=0.8 w=1.2 V/M 

8 Series Toggles

Part Numbering

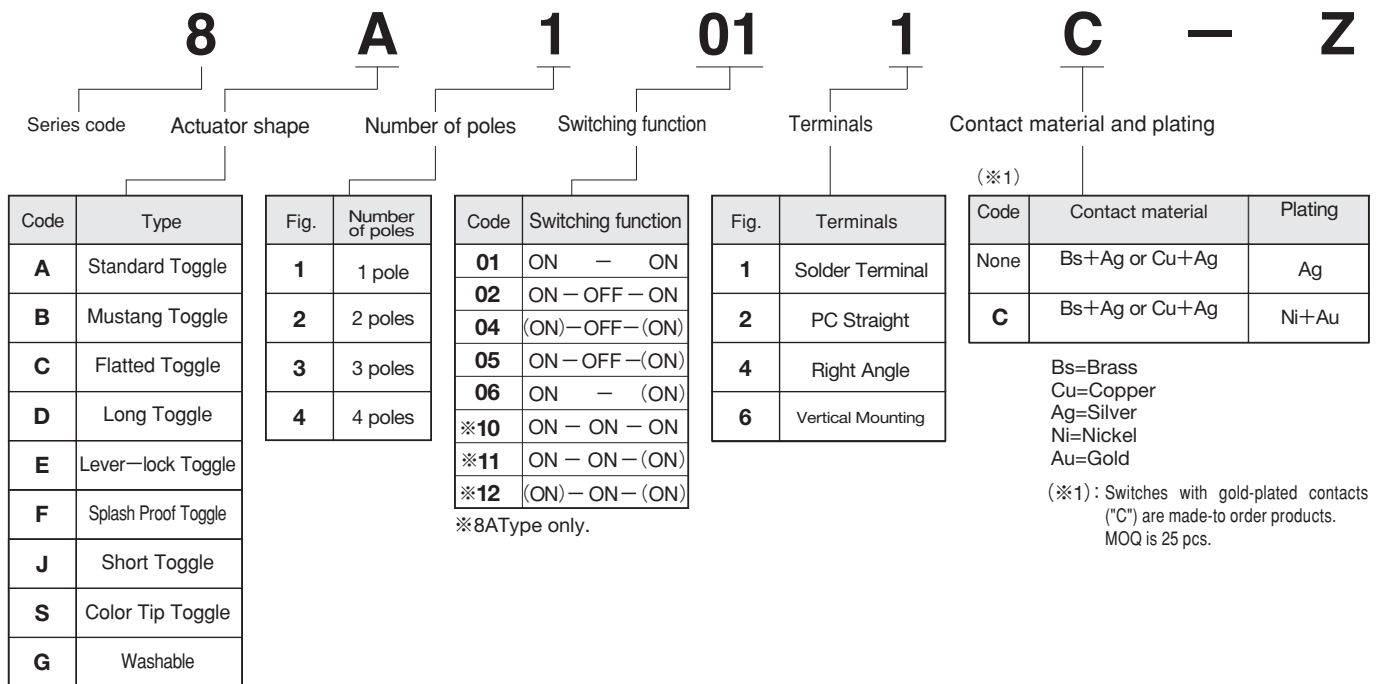

Note : Some combinations may not be available. Please check the "Table of Part Numbers" for each series.

8 Series Toggles Common Specifications

Contact specs.		Silver	Gold
Rating	Max.	AC125V 6A AC250V 3A DC30V 4A	AC125V 6A AC250V 3A DC20V 25mA
Initial contact resistance		10mΩ Max. (DC2~4V 1A)	20mΩ Max. (AC200μV 1.5mA)
Initial dielectric strength		AC1500V 1 minute	
Initial insulation resistance		1000MΩMin. (DC500V)	
Electrical life	Alternate type	50,000cycles	
	Momentary type	25,000cycles	
Operating temperature range		-30~+85°C	
Storage temperature range		-40~+85°C	

(ON) : Momentary.

8A

Standard Bat Toggle Switch

RoHS Compliant



Features

The 8A series has a 10.5mm bat toggle.

Table of Part Numbers

Terminal Style	Number of poles		1 pole	2 poles	3 poles	4 poles
	Switching Function					
Solder Lug	ON — ON		8A1011-Z ☆ 8A1011C-Z	8A2011-Z ☆ 8A2011C-Z	☆ 8A3011-Z ★ 8A3011C-Z	☆ 8A4011-Z ★ 8A4011C-Z
	ON — OFF — ON		8A1021-Z ★ 8A1021C-Z	☆ 8A2021-Z ★ 8A2021C-Z	★ 8A3021-Z ———	★ 8A4021-Z 8A4021C-Z
	(ON) — OFF — (ON)		☆ 8A1041-Z ★ 8A1041C-Z	☆ 8A2041-Z ▲ 8A2041C-Z	——— ▲ 8A3041C-Z	★ 8A4041-Z ▲ 8A4041C-Z
	ON — OFF — (ON)		☆ 8A1051-Z ☆ 8A1051C-Z	☆ 8A2051-Z ———	★ 8A3051-Z ▲ 8A3051C-Z	★ 8A4051-Z ▲ 8A4051C-Z
	ON — — (ON)		☆ 8A1061-Z ☆ 8A1061C-Z	☆ 8A2061-Z ☆ 8A2061C-Z	★ 8A3061-Z ▲ 8A3061C-Z	★ 8A4061-Z ▲ 8A4061C-Z
	ON — ON — ON		———	☆ 8A2101-Z ▲ 8A2101C-Z	———	★ 8A4101-Z ▲ 8A4101C-Z
	ON — ON — (ON)		———	★ 8A2111-Z ▲ 8A2111C-Z	———	★ 8A4111-Z ▲ 8A4111C-Z
	(ON) — ON — (ON)		———	★ 8A2121-Z ▲ 8A2121C-Z	———	★ 8A4121-Z ▲ 8A4121C-Z
Straight PC	ON — ON		8A1012-Z ☆ 8A1012C-Z	8A2012-Z ★ 8A2012C-Z	8A3012-Z ★ 8A3012C-Z	★ 8A4012-Z ▲ 8A4012C-Z
	ON — OFF — ON		☆ 8A1022-Z ☆ 8A1022C-Z	☆ 8A2022-Z ★ 8A2022C-Z	★ 8A3022-Z ▲ 8A3022C-Z	★ 8A4022-Z ▲ 8A4022C-Z
	(ON) — OFF — (ON)		☆ 8A1042-Z ☆ 8A1042C-Z	☆ 8A2042-Z ———	★ 8A3042-Z ▲ 8A3042C-Z	▲ 8A4042-Z ▲ 8A4042C-Z
	ON — OFF — (ON)		▲ 8A1052-Z ▲ 8A1052C-Z	☆ 8A2052-Z ▲ 8A2052C-Z	▲ 8A3052-Z ▲ 8A3052C-Z	▲ 8A4052-Z ▲ 8A4052C-Z
	ON — — (ON)		★ 8A1062-Z ☆ 8A1062C-Z	☆ 8A2062-Z ▲ 8A2062C-Z	▲ 8A3062-Z ▲ 8A3062C-Z	——— ▲ 8A4062C-Z
	ON — ON — ON		———	★ 8A2102-Z ▲ 8A2102C-Z	———	▲ 8A4102-Z ▲ 8A4102C-Z
	ON — ON — (ON)		———	▲ 8A2112-Z ▲ 8A2112C-Z	———	▲ 8A4112-Z ▲ 8A4112C-Z
	(ON) — ON — (ON)		———	▲ 8A2122-Z ▲ 8A2122C-Z	———	▲ 8A4122-Z ▲ 8A4122C-Z

Optional Accessories Page 415.

Color Cap					
Dimensions	Color	Part. No.	Dimensions	Color	Part. No.
	White	140000470030		White	140000470038
	Red	140000470098		Red	140000470100
	Black	140000470031		Black	140000470039
	Gray	140000470037		Gray	140000470077

PC Hole Layouts Page 414.

Panel Cut-Out Dimensions ... Page 414.

Terminal Styles Page 387.

Standard accessories ... Page 414.

 : Optional Accessories. (ON) : Momentary. ● For soldering and flux cleaning specifications, please refer to P.413. ★ : Made to order products.
 ☆ : Semi-standard products. ▲ : Inquiry products.

8A

SPDT

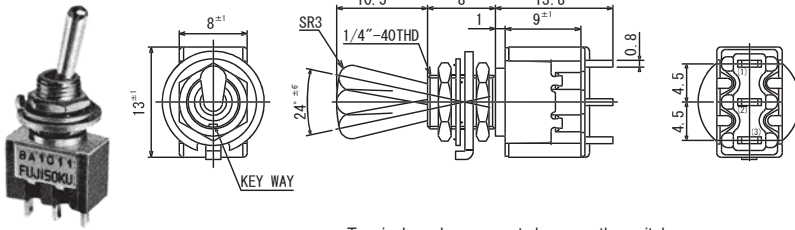

Terminal numbers are not shown on the switch.

Switching function	Key way	Key way	Key way
Part No.			
8A101■-Z	ON	—	ON
8A102■-Z	ON	OFF	ON
8A104■-Z	(ON)	OFF	(ON)
8A105■-Z	ON	OFF	(ON)
8A106■-Z	ON	—	(ON)
Connecting terminals	2-3	—	2-1

■ : Please refer to "Table of Part Numbers" on P.389 for a list of full part numbers.

DPDT

Dimensions	A	B
Part No.		
8A2011~2061	9±1	13.8±1
8A2001~2121	11.9±1	16.2±1

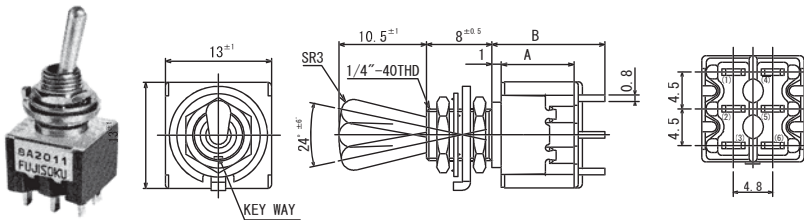

Terminal numbers are not shown on the switch.

Switching function	Key way	Key way	Key way
Part No.			
8A201■-Z	ON	—	ON
8A202■-Z	ON	OFF	ON
8A204■-Z	(ON)	OFF	(ON)
8A205■-Z	ON	OFF	(ON)
8A206■-Z	ON	—	(ON)
Connecting terminals	2-3 5-6	—	2-1 5-4
8A210■-Z	ON	ON	ON
8A211■-Z	ON	ON	(ON)
8A212■-Z	(ON)	ON	(ON)
Connecting terminals	2-3 5-6	2-3 5-4	2-1 5-4

■ : Please refer to "Table of Part Numbers" on P.389 for a list of full part numbers.

3PDT

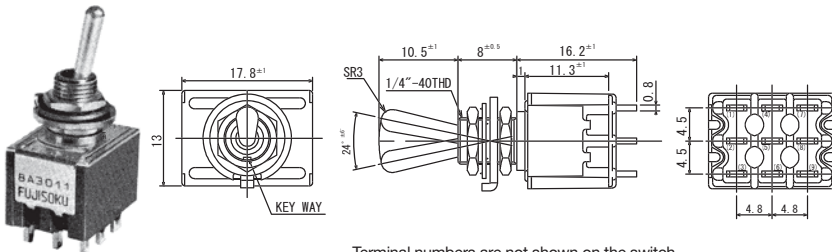

Terminal numbers are not shown on the switch.

Switching function	Key way	Key way	Key way
Part No.			
8A301■-Z	ON	—	ON
8A302■-Z	ON	OFF	ON
8A304■-Z	(ON)	OFF	(ON)
8A305■-Z	ON	OFF	(ON)
8A306■-Z	ON	—	(ON)
Connecting terminals	2-3 5-6 8-9	—	2-1 5-4 8-7

■ : Please refer to "Table of Part Numbers" on P.389 for a list of full part numbers.

4PDT

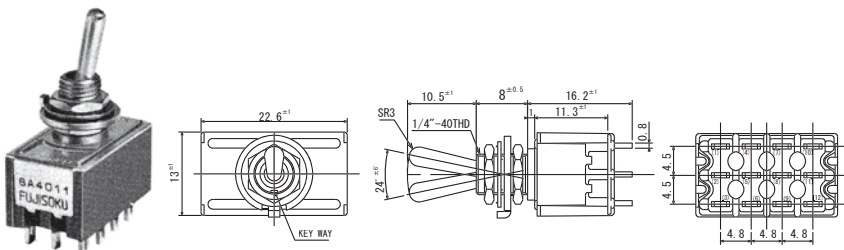

Terminal numbers are not shown on the switch.

Switching function	Key way	Key way	Key way
Part No.			
8A401■-Z	ON	—	ON
8A402■-Z	ON	OFF	ON
8A404■-Z	(ON)	OFF	(ON)
8A405■-Z	ON	OFF	(ON)
8A406■-Z	ON	—	(ON)
Connecting terminals	2-3 5-6 8-9 11-12	—	2-1 5-4 8-7 11-10
8A410■-Z	ON	ON	ON
8A411■-Z	ON	ON	(ON)
8A412■-Z	(ON)	ON	(ON)
Connecting terminals	2-3 5-6 8-9 11-12	2-3 5-4 8-9 11-10	2-1 5-4 8-7 11-10

■ : Please refer to "Table of Part Numbers" on P.389 for a list of full part numbers.

※Please refer to the next page for products marked with ※.

Three ON Switches

These switches are designed so that the Switching Function will be ON in all three positions. Extra wiring is required by the customer to get the three ON options. Please see below.

1 Circuit 3 Contacts

Function

Actuator position	Key way	Key way	Key way
Circuit diagram			
Switching function	ON	ON	ON
	(ON)	ON	(ON)
Connecting terms.	2-6	2-4	2-1

External wiring (to be wired by the customer)
 (ON) Momentary action.

Part Number Table

	ON-ON-ON	ON-ON-(ON)	(ON)-ON-(ON)
EIGHT Switch Series	8A2101-Z	8A2111-Z	8A2121-Z
	8A2101C-Z	8A2111C-Z	8A2121C-Z
	8A2102-Z	8A2112-Z	8A2122-Z
	8A2102C-Z	8A2112C-Z	8A2122C-Z

2 Circuit 3 Contacts

Function

Actuator position	Key way	Key way	Key way
Circuit diagram			
Switching function	ON	ON	ON
	(ON)	ON	(ON)
Connecting terms.	2-6 8-12	2-4 8-10	2-1 8-7

External wiring (to be wired by the customer)
 (ON) Momentary action.

Part Number Table

	ON-ON-ON	ON-ON-(ON)	(ON)-ON-(ON)
EIGHT Switch Series	8A4101-Z	8A4111-Z	8A4121-Z
	8A4101C-Z	8A4111C-Z	8A4121C-Z
	8A4102-Z	8A4112-Z	8A4122-Z
	8A4102C-Z	8A4112C-Z	8A4122C-Z

■Precautions (8A • 8B • 8C • 8D • 8E • 8F • 8J • 8S • 8SS)

1. Soldering Specifications

(1) Manual soldering

Device : Solder iron

①420°C Max. 3 sec. Max.

(2) Auto soldering

②275°C Max. 6 sec. Max.

The above-stated soldering conditions shall apply only to switches with straight terminals. Auto soldering is not possible with right-angle terminals. Switches with right-angle terminals should be soldered manually according to the conditions specified in (1) above.

(3) When soldering two or more terminals to the common land, use the solder resist to isolate the terminals.

3. Mounting

- Do not bend the terminals before mounting the switch on the PC board.
- After mounting the switch, do not place the device in such a way that the device weight will be applied on to the actuator of the switch.
- For switches with straight terminals, solder the switch on the PC board after fixing the switch on the panel with a nut.

2. Flux Cleaning

(1) Solvent : Fluorine or Alcohol type.

(2) 8A/B/C/D/E/F/J/S series are not washable. To wash the PC board, clean the soldering surface of the PC board with a brush so that the switch is not exposed to the cleaning solution.

(3) Cleaning after soldering should be done after the terminal temperature falls to 90°C or below, or after leaving the switch for five minutes or longer at room temperature.

■Packaging Specification

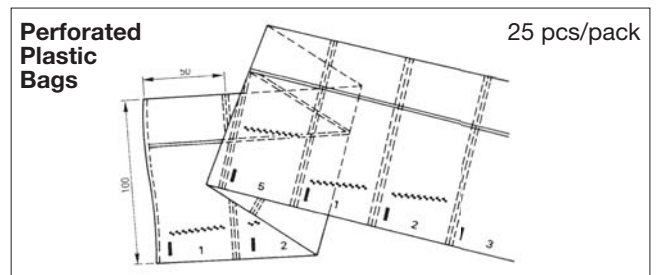

(ON) : Momentary.

◆ 8 Series Toggles ◆

■ Panel Cut-Out Dimensions

Series	8A·8D·8J·8S	8C	8E	8A·8D·8J·8S	8C	8E	8F
Panel thickness	2.5 mm Max.	2.4 mm Max.	1.5 mm Max.	3.5 mm Max.	3.4 mm Max.	2.5 mm Max.	5 mm Max.
Dimensions	<p style="text-align: center;">With Locking Ring</p>			<p style="text-align: center;">Without Locking Ring</p>			
Series	8B						
Panel thickness	5.9 mm Max.			6.9 mm Max.			
Dimensions	<p style="text-align: center;">With Locking Ring</p>			<p style="text-align: center;">Without Locking Ring</p>			

■ PC Hole Layouts

Series	8A · 8B · 8C · 8D · 8E · 8F · 8J · 8S
Dimensions	

■ Standard Accessories

Part Name	(Q'ty / switch)							
	Dress Nut	Hex Nut	Lockwasher	Locking Ring	O-Ring	Hex Nut	Lockwasher	Locking Ring
Part No.	140008010253	140008010241	140008030051	140008020062	14000610076	140008010243	140008030055	140008020065
Dimensions								
Finish	Nickel plated		Zinc plated		Nitrile rubber (Black)	Nickel plated	Zinc plated	
8A		2	1	1				
8B						2	1	1
8C	1	1	1	1				
8D		2	1	1				
8E		2	1	1				
8F		1	1		1			
8J		2	1	1				
8S		2	1	1				

● Numbers in the above chart show the quantities of each accessories enclosed with the switch.

Optional Accessories

《Sold separately》

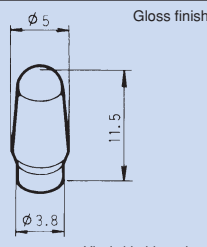
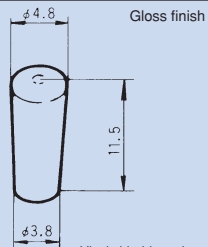
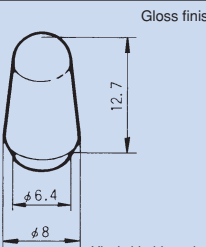
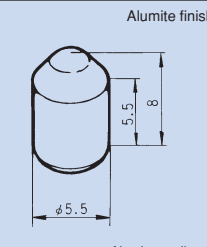
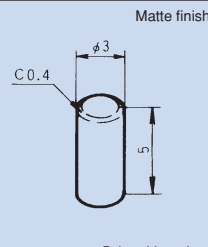
Type	8A · 8F · 8GA BT	8A · 8F · 8GA BT	8B	8E	8S · 8GS
Part Name	Color Cap				Color Tip
Dimensions					
Silver	—	—	—	140000470058	—
White	140000470030	140000470038	140000470063	—	140000470118
Red	140000470098	140000470100	140000470108	140000470060	140000470119
Black	140000470031	140000470039	140000470064	140000470059	140000470112
Gray	140000470037	140000470077	140000470102	—	140000470120

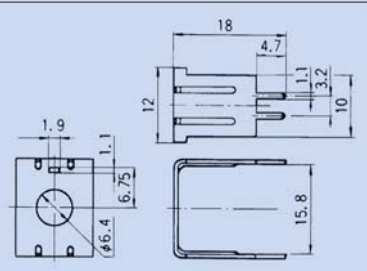
Type	8A · 8C · 8D · 8J · 8S 1, 2 poles*
Part Name	Bracket
Part No.	140000260715
Dimensions	

※The Bracket cannot be used with switches with switching functions "10", "11", or "12" (ref. P.388). The size of the housings are different in switches with switching functions "10", "11", and "12" and the Bracket cannot be used.

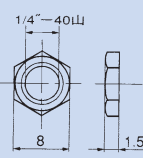
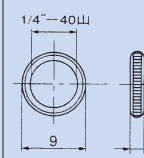
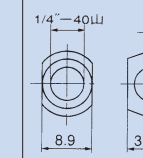
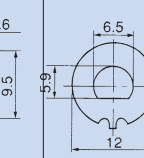
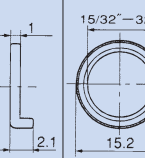
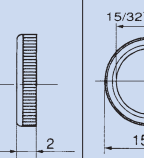
Type	8A · 8C · 8D · 8E · 8J · 8N · 8S · 8R			8F · 8P	8B · 8Y	
Part Name	Lock Nut	Round Nut	Pocketed Nut	Locking Ring	Round Nut	Round Nut
Part No.	140008010276	140008010258	140008010274	140008020066	140008010272	140008010273
Dimensions						
Finish	Nickel	Chromium	Nickel	Zinc	Chromium	

Type	8A	8B	
Part Name	Boot	Plate	Plate
Part No.	140000470422	140008040021	140008040025
Dimensions			

Table of 8 Series Toggles UL and CSA Listed

8 Series Toggles

Poles	Switching Function			UL (※1.)								CSA (※2.)							
				8A	8B	8C	8D	8E	8F	8J	8S	8A	8B	8C	8D	8E	8F	8J	8S
1 pole	101□	ON	—	ON	○	○	○	○	○	○	○	○	○	○	○	○	○	○	○
	102□	ON	—	OFF	—	ON	○	○	○	○	○	○	○	○	○	○	○	○	○
	104□	(ON)	—	OFF	—	(ON)	○	○	○	○	○	○	○	○	○	○	○	○	○
	105□	ON	—	OFF	—	(ON)	○	○	○	○	○	○	○	○	○	○	○	○	○
	106□	ON	—	(ON)	○	○	○	○	○	○	○	○	○	○	○	○	○	○	○
2 poles	201□	ON	—	ON	○	○	○	○	○	○	○	○	○	○	○	○	○	○	○
	202□	ON	—	OFF	—	ON	○	○	○	○	○	○	○	○	○	○	○	○	○
	204□	(ON)	—	OFF	—	(ON)	○	○	○	○	○	○	○	○	○	○	○	○	○
	205□	ON	—	OFF	—	(ON)	○	○	○	○	○	○	○	○	○	○	○	○	○
	206□	ON	—	(ON)	○	○	○	○	○	○	○	○	○	○	○	○	○	○	○
	210□	ON	—	ON	—	ON	○							○					
	211□	ON	—	ON	—	(ON)	○							○					
212□	(ON)	—	ON	—	(ON)	○							○						
3 poles	301□	ON	—	ON	○	○	○	○	○	○	○	○	○	○	○	○	○	○	○
	302□	ON	—	OFF	—	ON	○	○	○	○	○	○	○	○	○	○	○	○	○
	304□	(ON)	—	OFF	—	(ON)	○	○	○	○	○	○	○	○	○	○	○	○	○
	305□	ON	—	OFF	—	(ON)	○	○	○	○	○	○	○	○	○	○	○	○	○
	306□	ON	—	(ON)	○	○	○	○	○	○	○	○	○	○	○	○	○	○	○
4 poles	401□	ON	—	ON	○	○	○	○	○	○	○	○	○	○	○	○	○	○	○
	402□	ON	—	OFF	—	ON	○	○	○	○	○	○	○	○	○	○	○	○	○
	404□	(ON)	—	OFF	—	(ON)	○	○	○	○	○	○	○	○	○	○	○	○	○
	405□	ON	—	OFF	—	(ON)	○	○	○	○	○	○	○	○	○	○	○	○	○
	406□	ON	—	(ON)	○	○	○	○	○	○	○	○	○	○	○	○	○	○	○
	410□	ON	—	ON	—	ON	○							○					
	411□	ON	—	ON	—	(ON)	○							○					
	412□	(ON)	—	ON	—	(ON)	○							○					

(1) Terminal types: Solder terminal; Straight terminal

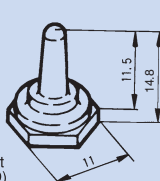
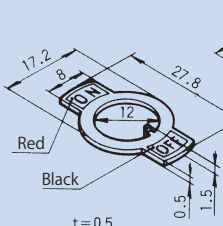
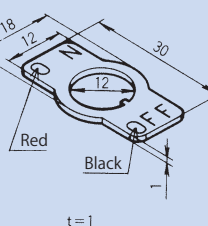
(2) **UL**-recognized switches: Solder terminals and straight terminals available for Single/Double/Three/Four Pole

(3) **CSA**-certified switches: Solder terminals and straight terminals available for Single Pole. Straight terminals available for Double/Three/Four Pole.

(4) UL, CSA marked switches available with additional charge.

(5) (※1.) **UL File No.E43275**
(※2.) **CSA File No.JR38341**

(6) As shown in the above chart, not all products are **UL**-recognized or **CSA**-certified. Please check with your local sales representative if you have any questions.